

The specimen under control - Specimen grips and test tools

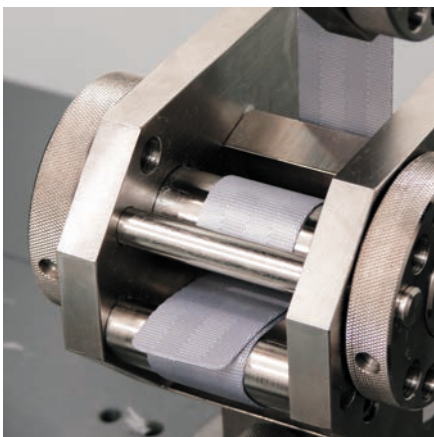
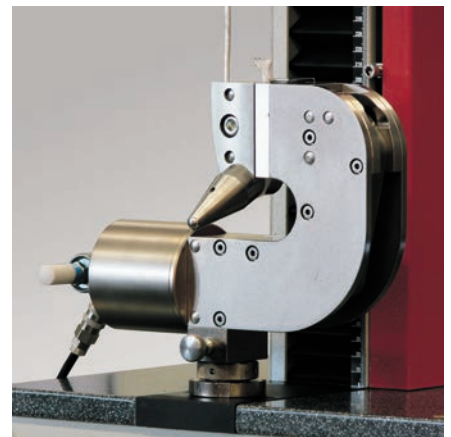
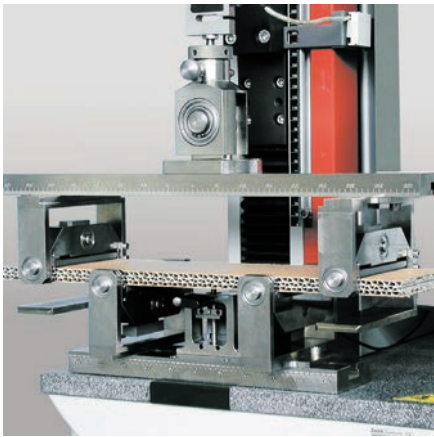

Table of contents

1	Zwick Roell – passionate customer orientation	2
2	Selection process for specimen grips / test tools	3
3	Specimen grips for tensile tests	4
3.1	Specimen grips actuated externally	6
3.2	Self-gripping specimen grips	9
4	Test tools for compression tests	14
5	Test tools for flexure tests	16
6	Further test tools	18
7	ZwickService	19

1 Welcome to Zwick Roell – passionate customer orientation

Zwick at a glance

For over 150 years the name of Zwick Roell has stood for outstanding technical competence, innovation, quality and reliability in materials and component testing. Our customers' confidence in us is reflected in our position as world-leaders in static testing and the significant growth we are experiencing in fatigue strength testing systems. With innovative product development, a comprehensive range and worldwide service, this family concern supplies tailor-made solutions for the most demanding requirements – in both research and development and quality assurance in over 20 sectors. With around 1000 employees, a production facility in Ulm, Germany, additional facilities in Europe, USA and Asia plus agencies in 56 countries worldwide, the Zwick brand name guarantees the highest product and service quality.

Customer orientation is the basis of our corporate philosophy. Dependability, straightforwardness and professionalism are the keynotes of our approach. Our aim is to build long-term customer relationships based on mutual trust – we value every customer, from large undertakings to small firms. We always give of our best. We help our customers to achieve greater success through expert advice, tailor-made solutions, innovative products and comprehensive services.

Zwick specimen grips and test tools

Zwick's wide range of specimen grips features a variety of designs, test-load ranges and test temperatures and covers the major application ranges of plastics, metals and component testing, while offering cutting-edge materials testing solutions to other industries such as medical technology.

Zwick has grips to suit all specimen materials and shapes. The range includes all established operating principles for specimen grips – non-positive (self or external) clamping and positive clamping.

In addition to specimen grips for tensile tests Zwick also supplies tools for compression and flexure tests and solutions for special applications.



The new center of Zwick in Ulm

2 Selection process for specimen grips / test tools

Selecting the test method

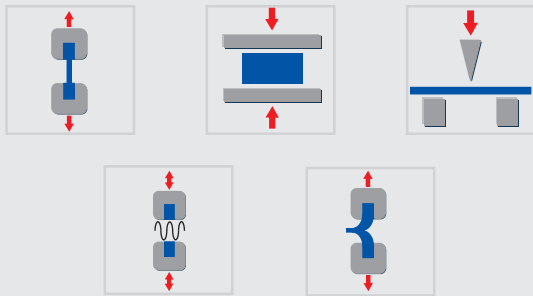

Specimen holders represent a basic requirement for every test. A safe, reliable test with accurate results is possible only if specimen grips and test tools are functioning correctly. For this reason it is essential to choose the correct specimen holder for each test.

With its broad range of specimen grips and tools Zwick covers the wide range of application for tensile, compression, flexure, tensile shear and cyclic tests.

Selection according to specimen material/shape

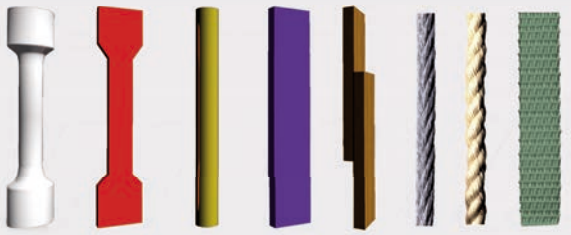

The differing design and operation of specimen grips makes each suitable for a different specimen shape, specimen dimension, material property and for the resulting load and deformation ranges.

The specific properties of the various materials, such as hardness, strength, ductility, elasticity and surface type or condition are a key factor in the selection of appropriate specimen grips.

Selecting the operating principle / mechanical requirements

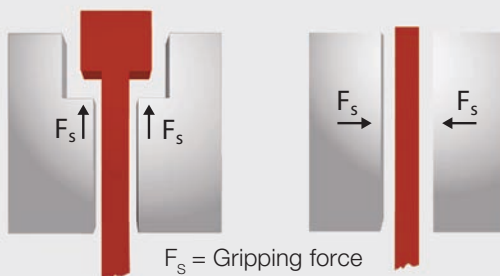

F_s = Gripping force

Gripping principle of positive and non-positive clamping

Depending on the specimen shape the load can be transmitted via positive or non-positive clamping. However, most tensile specimens are only suited to non-positive load transmission, as they are derived from wires, straps, belts, ropes, sheet metals or other sheet materials. Depending on the gripping force required and the gripped area available, the choice is between self-clamping and externally clamped specimen grips.

The mechanical requirements placed on specimens grips vary significantly, from load range and opening width to fluctuating temperature ranges.

Observing basic conditions

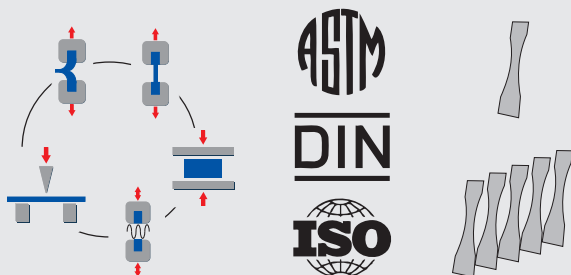

Due account must obviously be taken of specifications contained in standards when selecting specimen grips; in addition to this, attention must above all be paid to the basic test conditions. With a high specimen throughput, for example, automatic application of gripping force, as provided by pneumatic and hydraulic grips, is desirable. If many different tests are to be performed the specimen grips should be as flexible as possible. This reduces changeover time and cost and enhances operating convenience.

3 Specimen grips for tensile tests

Specimen grips form the mechanical link between the specimen and the testing machine. Their function is to transfer the movement of the crosshead or piston to the specimen and transmit the test load generated in the specimen to the load cell installed on the load frame.

The test most frequently applied is the tensile test. It places particularly high demands on the specimen grips as the test load is not, unlike in compression and flexure tests, applied perpendicularly to the specimen, but in precisely the opposite way. Tensile specimens therefore always require suitable shaping at the ends (heads) to transmit the test load to the specimen grips.

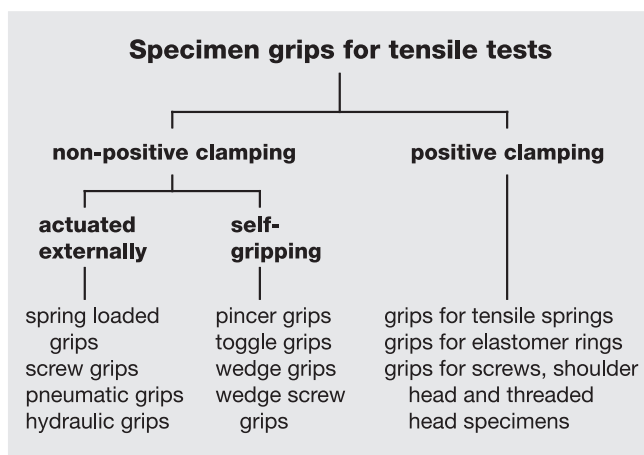

Specimen grips for force transmission via positive clamping

The test load is transmitted via a form fit with no additional forces involved. When metallic materials are tested, round dumbbell, conical-headed or threaded specimens are used for load transfer via positive clamping. For test flexible materials (rubber), by contrast, rings are punched or cut out of the material.

Specimen grips for force transmission via non-positive clamping

For most tensile specimens the test load can only be transmitted via non-positive clamping, as they are derived from wires, straps, belts, ropes, sheet metals or other sheet materials. With these specimen grips the necessary frictional forces are generated via flat clamping or using the capstan principle.

Self-clamping specimen grips

With self-clamping specimen grips the gripping force is derived from the test load, amplified via levers, wedges, eccentrics etc. and transmitted to the jaws. An initial holding force is applied, following which the gripping force is proportional to the tensile load. This category includes pincer, toggle, wedge and wedge-screw grips.

In the majority of self-clamping grips the change in grip travel due to bending of the grips and changes in specimen thickness also results in a change in the lever-arm ratios or even to a change in gripping force distribution along the grip-to-grip separation.

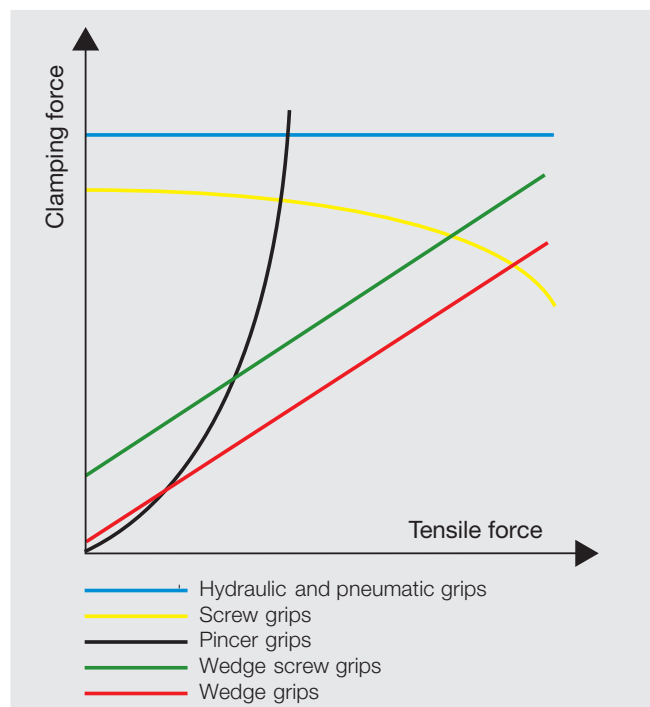

Externally actuated specimen grips

Specimen grips actuated by means of external energy always feature parallel clamping, so that the gripping force is independent of the tensile force. This group includes spring-loaded, pneumatic and hydraulic grips. With spring-loaded and screw grips the gripping force decreases due to a progressive reduction in specimen thickness during the course of the test. This reduction in gripping force is less for spring-loaded grips ('soft' spring) than with screw grips ('hard' spring).



Qualitative course of the gripping force depending on the tensile force and different gripping principles

Selection criteria for specimen grips

Characteristics/Features	Specimen grips (Function principle)							
	Screw-	Spring loaded-	Pneumatic-	Hydraulic-	Wedge-	Wedge screw-	Pincer-	Toggle-
Size (max. test load)								
Smallest version [kN]	0.02	0.02	0.02	10	2.5	0.5	0.5	0.3
Largest version [kN]	50	0.05	100	2000	600	250	10	2.5
Temperature range								
Lower limit [°C]	-70	-15	-70	-70	-70	-40	-40	-15
Upper limit [°C]	+250	+80	+250	+250	+250	+250	+250	+80
Main range of application								
 Plastics								
Sheets, strips	✓	✓	✓	-	-	-	-	✓
Tapes	✓	-	✓	✓	-	-	-	-
Monofilament	-	-	✓	✓	✓	-	-	-
Strings, ropes	✓	-	✓	-	-	-	-	-
Dumbbells	✓	-	✓	✓	✓	✓	✓	-
 Metal								
Foils	✓	-	✓	-	-	✓	✓	-
Sheets, thin sheets	✓	-	✓	-	✓	✓	✓	-
Wires, fine wires	✓	✓	✓	✓	✓	✓	-	-
Strips	✓	-	✓	✓	✓	✓	-	-
Pipes	✓	-	✓	✓	✓	✓	-	-
Dumbbells	✓	-	✓	✓	✓	✓	-	-
Flat specimens	✓	-	✓	✓	✓	✓	✓	-
Round specimens	✓	-	✓	✓	✓	✓	-	-
Profiles	-	-	-	✓	-	-	-	-
 Textiles								
Filaments, fine yards	✓	✓	-	-	-	-	-	-
Elastic yarns	-	✓	-	-	-	-	-	-
General yarn	✓	-	✓	-	-	-	-	-
Technical yarn	-	-	✓	-	-	-	-	-
Non-woven fabrics	✓	-	✓	✓	-	-	-	✓
General fabric	✓	-	✓	✓	-	-	-	-
Technical fabrics	-	-	✓	✓	-	-	-	-
Geo-fabrics	-	-	-	✓	-	-	-	-
String, ropes	-	-	✓	-	-	-	-	-
Cordage, conveyor belts	✓	-	✓	✓	✓	✓	✓	-

Specimen grips for additional applications, including medical technology, are described in Section 3.3.

3.1 Specimen grips actuated externally

3.1.1 Screw grips

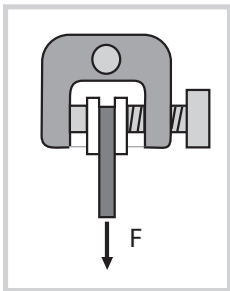

In screw grips the gripping force is applied manually or via an electric motor. These grips are used mostly for smaller test loads (from 20 N to 50 kN) and thinner specimens – fine wires, fibers, films.

The maximum opening width is 31 mm (varies according to jaw insert).

The standard range of application includes test temperatures between -70°C and $+250^{\circ}\text{C}$. The gripping force depends on the screw torque and grip compliance.

Further features:

- Very easy to operate
- Large opening widths for flexibility in use
- Most commonly used screw grips are U-shaped for good accessibility
- Simple design principle enables standard version to be resistant to high temperatures

Highlight: spring loaded grips

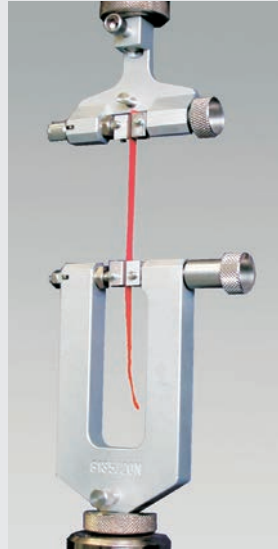

These grips are particularly suitable for tests involving very low forces. Their weight is sufficiently low in relation to the nominal force of the attached load cell as to impose no restrictions on the force measurement range of the load cell. The gripping force is generated by a spring. The spring force can be pre-set, allowing clamping-sensitive materials always to be tested using the same gripping force.

- Depending on type these grips have an axial bearing in the gripping unit for increased gripping forces
- Many screw grips feature free adjustment of both jaws, allowing asymmetrical specimens to be tested

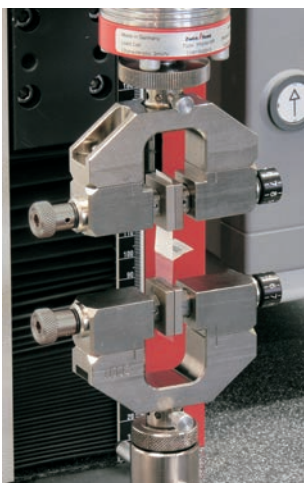

Fig. 1: Screw grips 200 N



Fig. 2: Screw grips 500 N



Fig. 3: Screw grips 2,5 kN

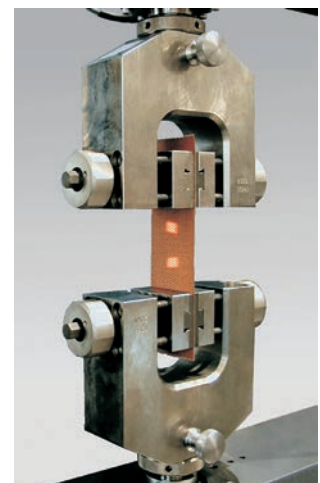
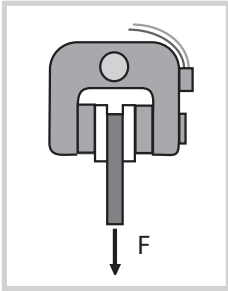

Fig. 4: Screw grips 20 kN

3.1.2 Pneumatic grips



Pneumatic grips are particularly useful when a variety of materials must be held, especially clamping-sensitive materials. The gripping force is generated by pneumatic cylinders acting directly on the jaws or via a lever system.

Features common to all pneumatic grips:

- Separation of tensile and closing forces ensures constant gripping force throughout the test sequence
- The contact force on the specimen is reproducible
- Zwick's force stabilization system protects the specimen from undesirable forces during the clamping process
- Clamping-sensitive specimens can be held securely by adjusting the pneumatic pressure, avoiding jaw breaks
- Tensile load application can be static or pulsating. Depending on the type of grips, compression and alternating load tests are also possible
- The larger grips can remain in place while small load cells, specimen grips, test tools and test devices are attached to them – a great time-saver

Highlight: grips for temperature chambers

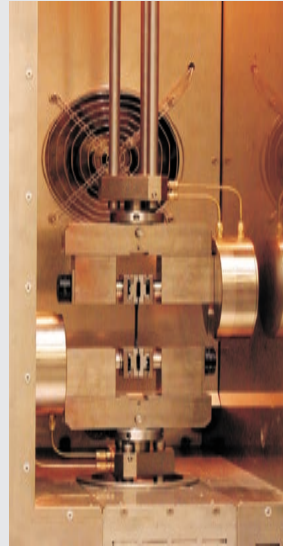

These grips can be used for both symmetrical and asymmetrical gripping of specimens (as in shear tensile tests). They have special connector units for use in temperature chambers with integrated compressed air supply, plus a drip tray for separate drainage of condensed water from the test area. The counter-jaw can be adjusted steplessly or in steps.

Zwick pneumatic grips are divided into two types:

- **Single-actuator** pneumatic grips are used for symmetrical and asymmetrical clamping of specimens. Some of the single-actuator pneumatic grips up to 1kN have an integrated servo valve and require no additional external pneumatic control unit.
- **Double-actuator** pneumatic grips always close symmetrically to the tensile axis, eliminating the need for thickness adjustment – a great advantage, especially with soft specimens and/or varying specimen thicknesses.

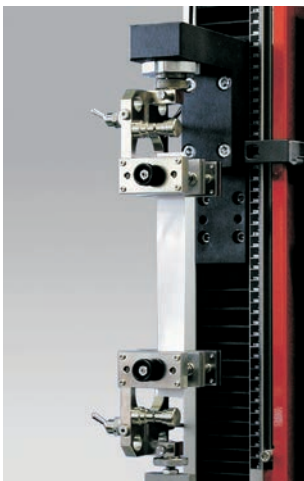

Fig. 1: Pneumatic grips 50 N

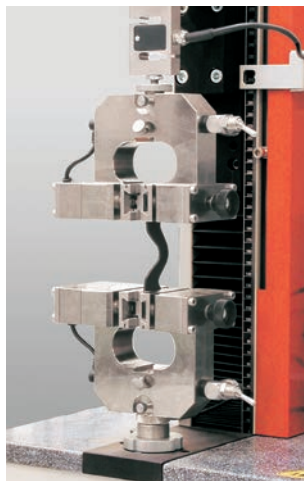

Fig. 2: Pneumatic grips 500 N

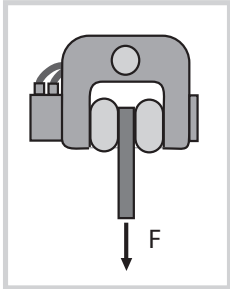

Fig. 3: Pneumatic grips 5 kN



Fig. 4: Pneumatic grips 50 kN

3.1.3 Hydraulic grips



Hydraulic grips are primarily used when test loads of 50 kN and over, with associated high gripping forces, are required (F_{max} from 10 kN to 2000 kN possible). The contact force is exactly reproducible.

Features common to all hydraulic grips:

- Defined force application ensures optimized gripping of sensitive materials
- Zwick's force stabilization system protects the specimen reliably from unwanted forces during the gripping process
- The standard version of the hydraulic grips from 50 kN to 250 kN features an excentric long-stroke piston, allowing deep positioning of the gripping surfaces and a large opening width to be achieved (max. opening width 78 mm)
- The T-slot system enables small load cells, specimen grips, test tools and devices to be mounted via T-slots incorporated into the lower part of the grip body
- The ratio between gripping and tensile forces can be adjusted individually, ensuring that the specimen is held securely (at maximum tensile force approximately double gripping force is required)

Highlight: short clamping grips



These hydraulic grips close symmetrically. The patented system actively counters the high turning moments which short clamped lengths impose on guides and actuators, enabling parallel, uniform gripping of short clamped lengths throughout the test. The patented guide system ensures accurate alignment in the test and load axis.

- Control is via a hydraulic power pack. Zwick supplies various versions, with operation via the pack remote control or that of the machine, depending on type. The power packs differ in the operating modes available:
 - one-off setting of operating pressure
 - re-tensioning
 - continuous gripping
 - proportional gripping
- Common to all power packs are high safety standards, including Emergency STOP chain and inching mode

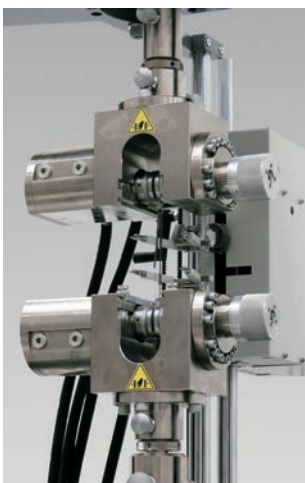

Fig. 1: Hydraulic grips 50 kN

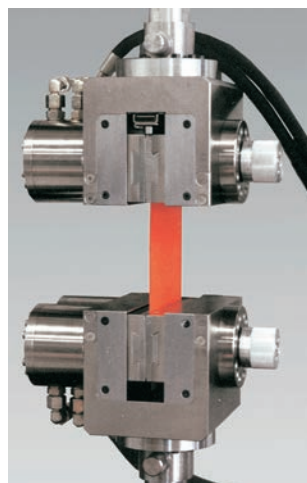

Fig. 2: Hydraulic grips mit Textil



Fig. 3: Hydraulic grips 250 kN



Fig. 4: Hydraulic grips 2000 kN

3.2 Self-gripping specimen grips

3.2.1 Wedge grips

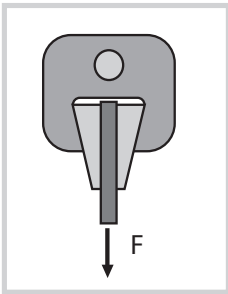

Wedge grips consist of a solid body with interchangeable jaw inserts or fixed jaws, plus a control to open and close the grips. The gripping area is freely accessible.

Lever actuation operating principle

Opening and closing is by means of a lever which moves the wedge jaws up and down. Both upper and lower grips are equipped with a locking device which holds the grips open for insertion of the specimen. Lever actuation ensures fast, energy-efficient operation.

The initial gripping force is generated by a pre-tensioned spring, the main gripping force being produced by the wedge action. A moving wedge maintains a constant relationship between gripping pressure and tensile force.

This ratio is determined by the wedge angle. Movement of the wedge during the test allows specimen strain to be measured exactly via direct extension measurement.

Highlight: 50 kN wedge grips



These grips operate on the 'body over wedge' principle. The initial gripping force on the specimen is transmitted to the jaws via the body by a screw drive. It is possible to set the desired grip-to-grip separation exactly before the test, regardless of specimen thickness or diameter. Additionally a pre-tensioning force can be applied, which is advantageous with materials prone to slippage.

Features common to all wedge grips:

- The gripping force is proportional to the tensile force (self-clamping)
- The grips close symmetrically, i.e. they always close in the tensile axis
- Good high-temperature resistance and low overall height make these grips highly suitable for use in temperature chambers



Fig. 1: Wedge grips 2,5 kN

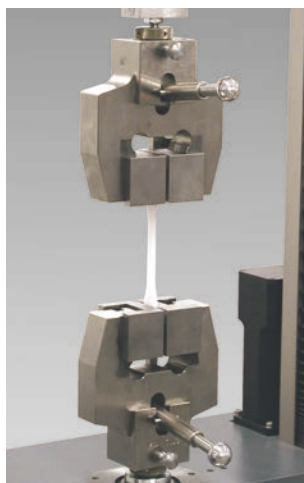

Fig. 2: Wedge grips 10 kN



Fig. 3: Wedge grips 100 kN

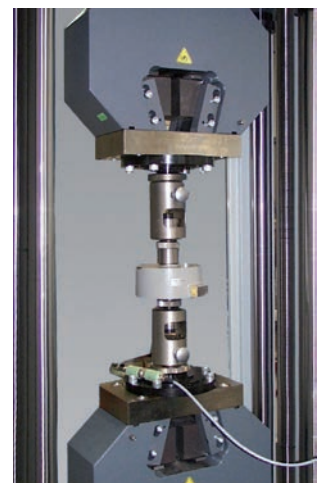
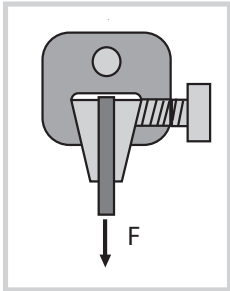

Fig. 4: Wedge grips 600 kN

3.2.2 Wedge-screw grips



Wedge-screw grips combine the mechanical properties of screw grips and wedge grips. Thickness adjustment and generation of initial gripping force are via screw action, eliminating slippage of the specimen at the beginning of the test.

Features of wedge-screw grips:

- The main gripping force is generated by the wedge action
- The gripping force is proportional to the actual tensile force (self-clamping), ensuring secure gripping of different materials
- Large grip-to-grip separation allows the surface pressure to be kept low, avoiding jaw breaks
- The larger grips can remain in place while small load cells, specimen grips, test tools and test devices are attached to them – a great time-saver
- Easy, tool-free jaw-insert change

Highlight: Switchable synchronization



Fig. 1: Symmetrical clamping



Fig. 2: Asymmetrical clamping

Switchable synchronization allows wedge-screw grips (F_{max} 10 kN and over) to grip both symmetrically and asymmetrically. Asymmetry is easy to set and is maintained securely even after re-clamping, enabling one-handed operation (with either hand) for asymmetrical specimens also and ensuring that the specimen attachment point is always in the test axis.

- Wedge-screw grips with F_{max} 50 kN and over can optionally be operated via a pneumatic motor, while opening and closing of the grips is by means of an electric motor; the control for this is located directly on the grips
- Low overall height



Fig. 3: Wedge-screw grips 500 N

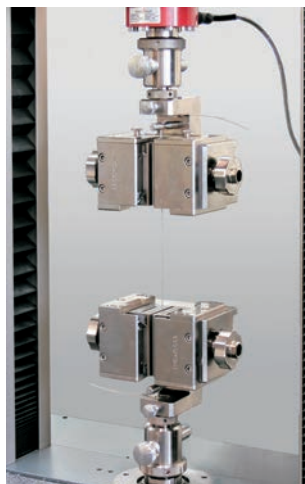

Fig. 4: Wedge-screw grips 10 kN

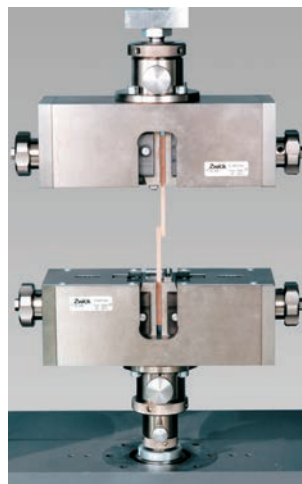

Fig. 5: Wedge-screw grips 30 kN with asymmetrical specimen

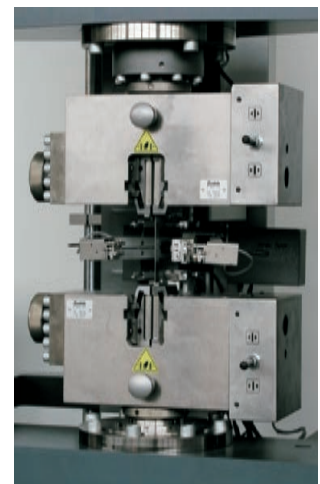
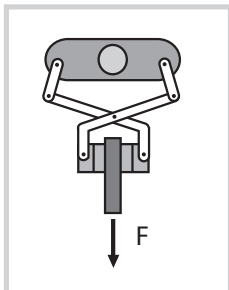

Fig. 6: Motor-driven wedge-screw grips 150 kN

3.2.3 Pincer grips



These grips are primarily used for testing highly ductile plastics and elastomers. The pincer principle produces a strong increase in gripping force during the test.

Features common to all pincer grips:

- The gripping force is proportional to the tensile force (self-clamping)
- The lateral mobility of the pincer grips allows specimens always to be loaded centrally to the test axis
- Design ensures fast, easy clamping



Fig. 1: Pincer grips 500 N



Fig. 2: Pincer grips 10 kN

- Good high-temperature resistance and low overall height make these grips highly suitable for use in temperature chambers

3.2.4 Toggle grips

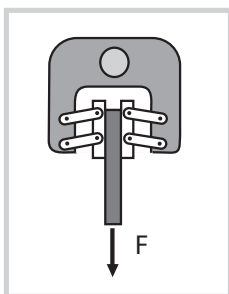

Toggle grips are self-clamping due to the action of the toggle lever. The specimen is inserted by raising the toggle lever and can be passed around the toggle lever or clamped directly as required.

Features of toggle grips:

- Design ensures quick, easy gripping
- Low overall height and temperature range make toggle grips ideal for use in temperature chambers



Fig. 3: Toggle grips 300 N

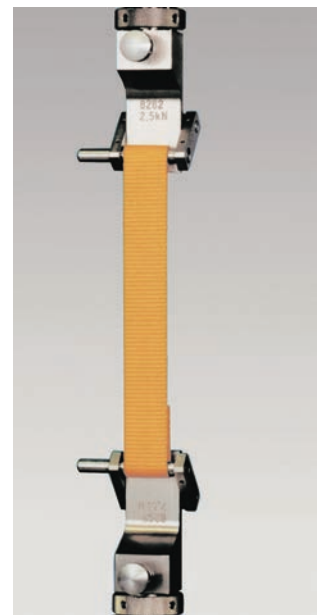

Fig. 4: Toggle grips 2,5 kN

3.3 Special grips for tensile tests

Grips for ropes



Tensile stress on the specimen is reduced by friction on the load reduction curve. The ends are clamped mechanically via a screw (with force amplification if required), a wedge or a hydraulic gripping unit.

- Maximum test load: 2.5 - 100 kN
- Tensile force reduction through single or multiple looping limits
- Interchangeable load-reduction rollers for optimum matching to specimen material
- Quick, easy specimen insertion requires little effort, making these grips suitable for series testing

Grips with deflection

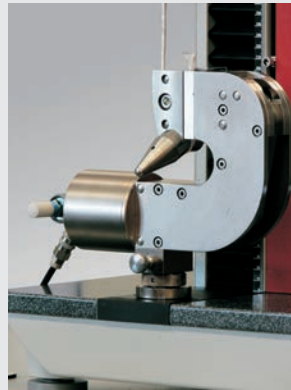

With these grips the force on the specimen is decreased as it passes around a load reduction curve, allowing lower gripping forces to be used in the end clamps. Maximum test load ranges from 500 N to 20 kN.

- With pneumatic end clamping the gripping force remains constant, allowing high specimen throughput
- Automatic centering of specimens via guide grooves in the load reduction curve
- Symmetrical weight reduction means that the center of gravity of the grips is located close to the tensile axis; no transverse forces are transmitted to the load cell via the grips

Roller grips



The gripping force is generated by self-clamping via multiple looping.

Exact strain measurement is performed using optical extensometer systems.

- Available with a maximum force measurement range of 2.5 kN to 250 kN
- Specimens are easily inserted into the gripping area, which features good front access (max. clamping width: 220 mm)
- Low overall height
- Suitable for tests in temperature chambers (temperature range -70 to +250 °C)

Grips for insulating materials

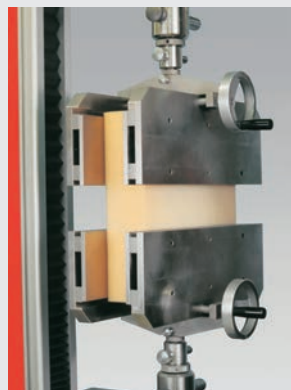

These grips are suitable for standard-compliant testing of insulating materials and can be used for forces up to 10 kN. The temperature range is between 0 and 50 °C and insulating material specimens up to 252 mm thick can be accommodated.

- The gripping stroke is symmetrical to the tensile axis, preventing bending moments on the specimen
- Secure gripping is ensured by protruding pins located in the jaws
- A support strip located in the center of the grips facilitates gripping and vertical alignment of the specimen

Grips for ring specimens

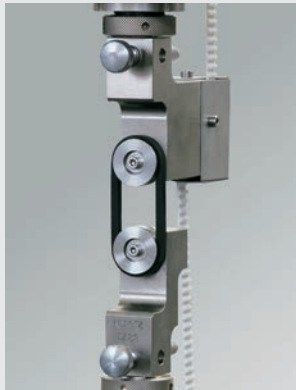

These grips are suitable for testing elastomer ring specimens to DIN 53 504, Standard Ring 1 & 2. Force transmission is by positive clamping via horizontally mounted rollers.

- The rollers rotate independently during the test via toothed belts or a coiled band spring and spiral mainspring
- Rollers are freely accessible for easy specimen insertion (max. specimen width 80 mm)
- Safety device available for protection against specimens being thrown off
- Fmax: 2.5 kN
- Temperature range: -40 to +150 °C

Self-aligning specimen grip



These self-aligning grips possess a rotating self-locking disc with various opening widths, allowing a large range of connecting elements to be tested; for example determining the pull-off force of cable-end ferrules and for tensile tests on catheter connectors.

- Maximum force: 500 N
- Disc locking feature enables tool-free changes between test environments
- Easy changeover to additional rotating discs
- Generous grip design height enables testing of large specimens (e.g. needle pull-out tests on hypodermics)

Grips for tensile springs



Force transmission is via horizontal hanging bolts available in various diameters (maximum spring wire diameter 6 mm).

- These grips are available in two versions, Type I with Fmax 50 N for fine spring wires and Type II with Fmax 10 kN
- Hanging bolts are freely accessible from the front for easy specimen mounting
- Temperature range: -70 to +250 kN

Grips for screws, shoulder head and threaded head specimens



Positive clamping force transmission via shoulder, screw or threaded heads. The specimen plus appropriate holder is inserted into the grips, which are freely accessible from in front, and is automatically centered in the tensile axis.

- Absolutely symmetrical force distribution (Fmax: 50 kN or 250 kN, temperature range: -70 to +250 °C)
- Anti-backlash option also ensures that the specimen holder is held rigidly minimizing holder recoil at specimen break
- Low overall height saves space in the test area
- Positive clamping solution eliminates need for additional hydraulic power packs

4 Test tools for compression tests

Compression tests are used to determine material behavior under uniformly increasing compression loading. This involves compressing a specimen until it either breaks or cracks or reaches an agreed level of compression.

The compression fixtures used are in immediate contact with the materials to be tested. They must therefore be precisely in line with and matched to the relevant applications and requirements.

There is a wide range of compression test kits for highly diverse tests. These compression fixtures can be individually tailored to special applications in accordance with the relevant requirements.

Compression test kits usually consist of two components, the upper and lower compression fixtures. To ensure maximum flexibility and versatility for use in individual tests, a comprehensive range of fixtures capable of being used in combination has been developed.



ProLine Z050 with compression test on form affusion parts

Setup principle for a compression test device:

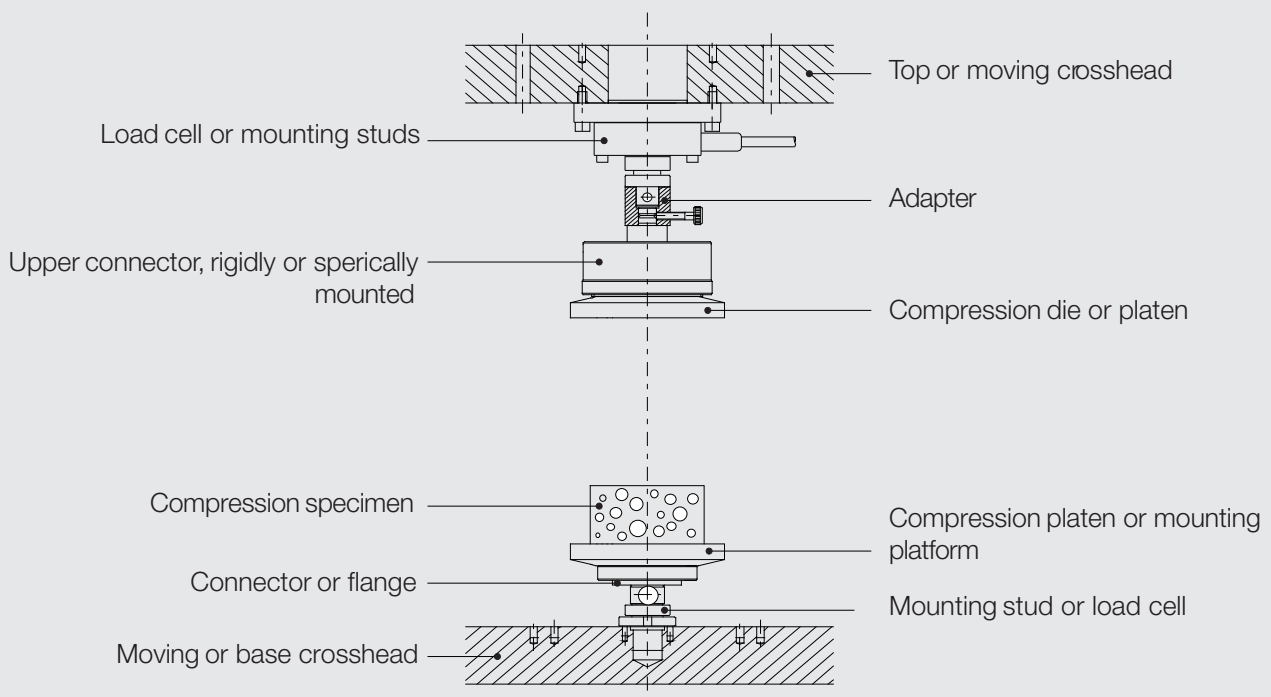

Selection criteria

Compression test kits must be selected to suit the relevant application. The differing requirements basically result from:

- the large number of different specimens, materials and components
- the wide variety of specimen shapes and dimensions
- the wide range of environmental conditions (temperature, humidity etc.)

To simplify selection of individual compression fixtures, the compression platens have been divided into light and heavy platens. The light compression platens are designed for compression tests with a maximum force of 20 kN, while heavy platens can be used for tests up to 250 kN.

Compression platens are also divided according to their external dimensions, a distinction being made between round and rectangular platens. The different dimensions of platens are shown as a selection criterion for each individual platen. The permitted surface pressure for platens depends on the material:

- aluminium (hard anodized/non-hard anodized) 90 N/mm²
- steel, surface hardened 300 N/mm²
- steel, hardened 800-1800 N/mm²
- steel, DNC hard 300 N/mm²
- steel, DNC treated 300 N/mm²



Fig. 1: PrecisionLine Manual



Fig. 2: Spring testing



Fig. 3: Foam testing with compression platen 120 x 120 mm



Fig. 4: Foam testing with compression platen 400 x 400 mm



Fig. 5: Compression test on cardboard



Fig. 6: Box-Crush-Test

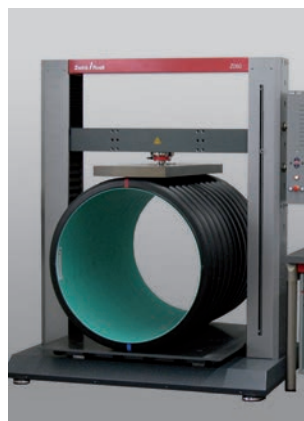

Fig. 7: Tests on tubes with inner diameter 800 mm

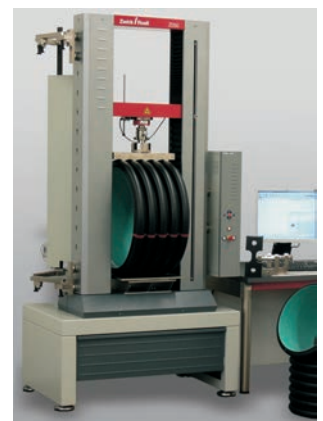

Fig. 8: Tubes testing according to ISO 9969

5 Test tools for flexure tests

Flexural loading represents one of the most frequently occurring types of load in practice and is therefore of great importance for materials testing on a wide range of materials. Flexure tests are used to determine mechanical material properties of steel, plastics, wood, paper, ceramics and other materials.

A 3-Point or 4-Point flexure test is generally used to determine characteristic values.

When a symmetrical cross-section is flexurally loaded, tensile stresses arise in the outer fibers on one side and compressive stresses in the opposing outer fibers. Stresses on both sides increase with the distance from the neutral axis, so that the highest values are always found in the outer zones. If the tensile or compressive yield point of the material is reached, plastic yield occurs.



ProLine Z010 with 3-Point flexure test on plasterboard

Setup principle for a 3-Point flexure test kit:

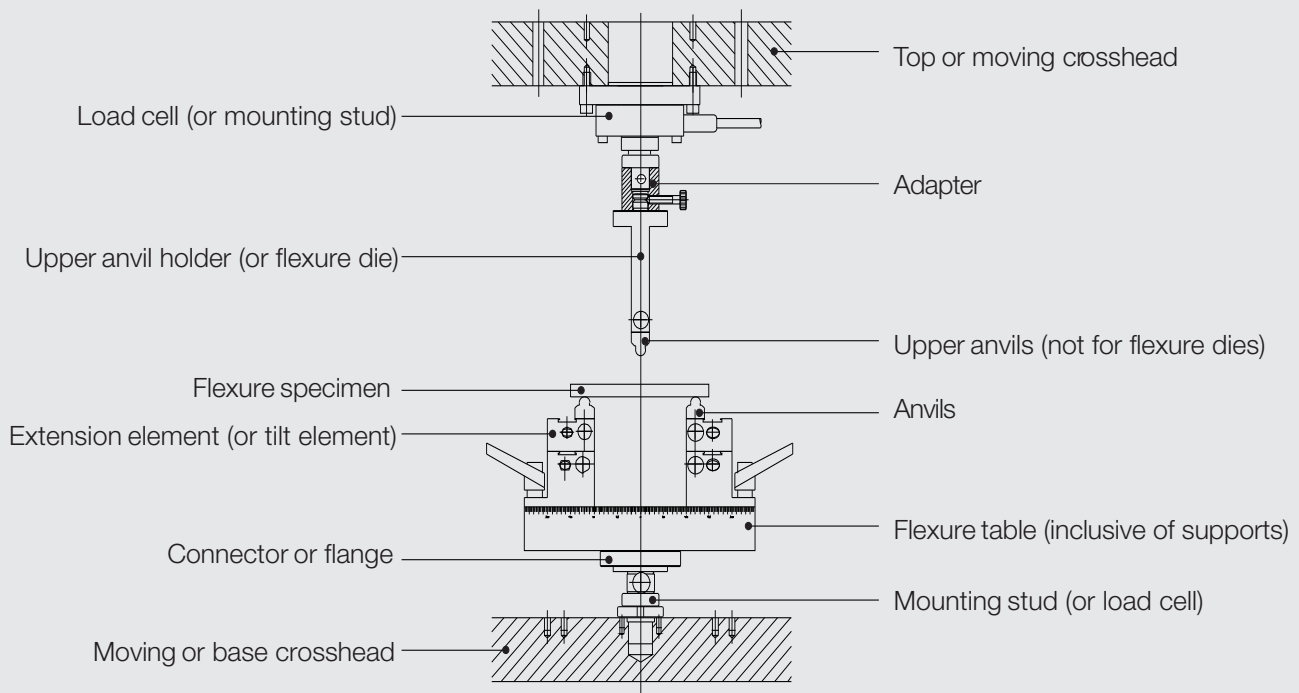

The 3-Point flexure test

The loading device consists of two parallel anvils which support the specimen and an upper anvil which applies the load to the specimen at a point midway between the first two anvils. For the test to be performed in accordance with requirements, the three anvils must be either fixed, rotating or tilting, depending on the test specifications (standard). The test is primarily used for ductile and elastic materials. To minimize frictional influences during the test the lower anvils can be mounted so as to rotate about their longitudinal axes. The three anvils can be provided with tilting mountings to ensure that they maintain parallel contact with the specimen.

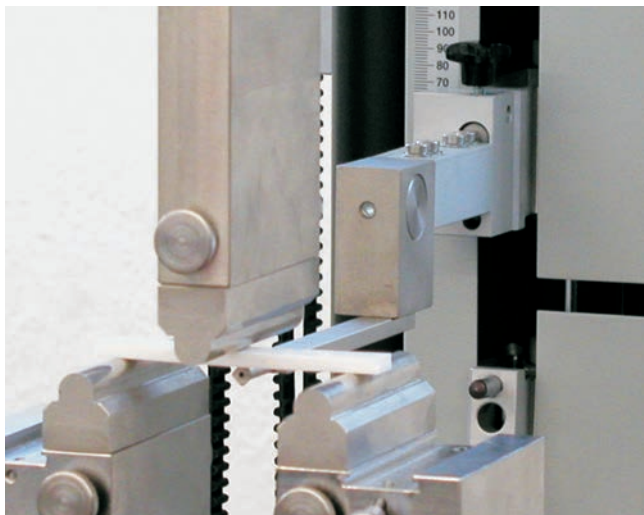

Fig. 1: 3-Point flexure test kit with sensor arm

The 4-Point flexure test

As with the 3-Point flexure test, the 4-point flexure test kit comprises two parallel anvils which, depending on the test, must be fixed, rotating or tilting.

The difference from the 3-Point flexure test lies in the way in which the force is applied to the specimen. This is done using two upper anvils positioned symmetrically to the lower anvils so that the bending moment between the two force application points remains constant. This test is primarily used for determining the flexure-elasticity modulus of brittle materials.

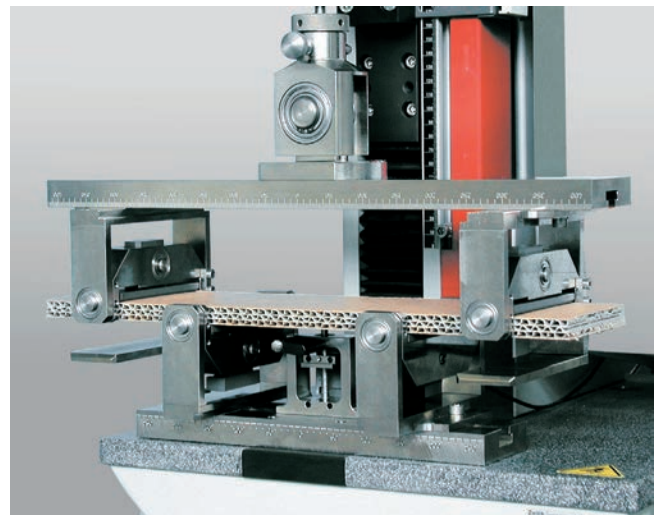

Fig. 2: 4-Point flexure test kit for tests on paperboard

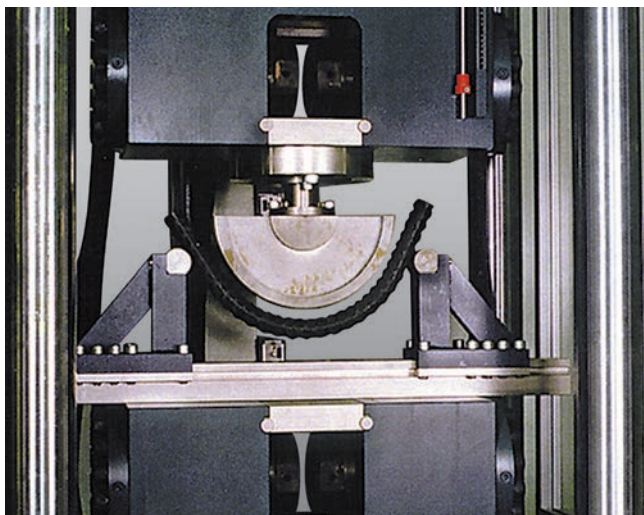

Fig. 3: 3-Point flexure test kit for tests on ripped bars



Fig. 4: 4-Point flexure test kit for tests on wooden beam

6 Further test tools

Test tools for tests on plastics



Fig. 1: Penetration test

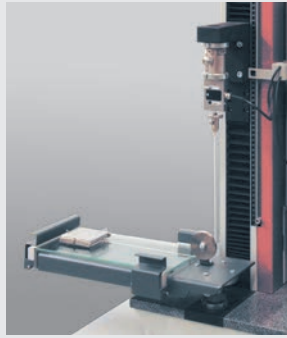

Fig. 2: Friction test



Fig. 3: 90°-Peel test



Fig. 4: HCCF test

Test tools for food testing



Fig. 5: Acc. AACC 74-09



Fig. 6: Butter testing



Fig. 7: Kramer shear test



Fig. 8: Viscosity test on honey

Test tools for tests on medical parts



Fig. 9: Test on injection needle



Fig. 10: Flexure test on ceramic



Fig. 11: Torsion test



Fig. 12: Piston stroke test

Test tools for tests on construction materials



Fig. 13: Shear test on wood



Fig. 14: Double ring flexure test

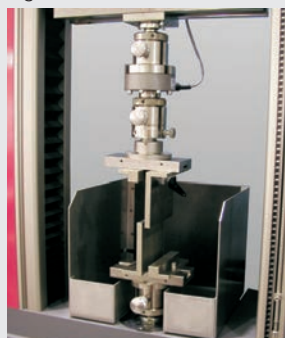

Fig. 15: Tiling testing



Fig. 16: Test on roof tiles

Specimen grips and test tools for every range of application

A feature of Zwick specimen grips and test tools is their wide range of possible uses. A large number of standardized solutions are available with regard to force range, opening width and temperature range. If there are no suitable specimen grips for a specific test, Zwick will produce suitable grips for you.



Fig. 1: Tests at sub-zero degrees

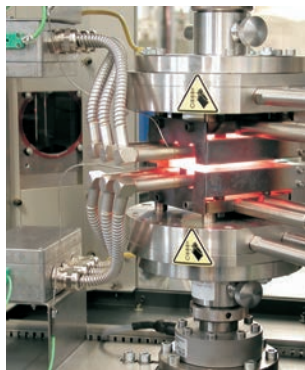

Fig. 2: Tests with heating plates



Fig. 3: Tests in tempered water basin

7 ZwickService

Applications Test Laboratory and contract testing

Over the last few years the Zwick Applications Test Laboratory has developed into a center of expertise for testing technology, with lively scientific exchanges.

Unsure which specimen grips are right for your application? Zwick offers you the opportunity to put this to a practical test for new modified or highly complex applications. Our Applications Test Laboratory with its experts and comprehensive equipment is ready and waiting.



Fig. 4: Application Test Lab at Zwick in Ulm

Zwick Roell AG

August-Nagel-Str. 11
D-89079 Ulm
Phone +49 7305 10 - 0
Fax +49 7305 10 - 200
info@zwickroell.com
www.zwickroell.com

Members of the Zwick Roell AG

Zwick GmbH & Co. KG

www.zwick.com

Indentec

Hardness Testing Machines Ltd.

www.indentec.com

Messphysik Materials Testing GmbH

www.messphysik.com

GTM Gassmann Testing and Metrology

www.gtm-gmbh.com



Your local company – worldwide

Zwick UK
www.zwick.co.uk

Zwick Ibérica
www.zwick.es

Zwick Avrasya
www.zwick.com.tr

Zwick Korea
www.zwick.co.kr

Zwick France
www.zwick.fr

Zwick Norge
www.zwick.no

Zwick USA
www.zwickusa.com

Zwick India
www.zwick.co.in

Zwick Belux
www.zwick.be

Zwick Sverige
www.zwick.se

Zwick Brazil
www.panambrazwick.com.br

Zwick Japan
www.zwick.jp

Zwick Netherlands
www.zwick.nl

Zwick CZ
www.zwick.cz

Zwick Asia
www.zwick.com.sg

Zwick Centro America
www.zwick.com.mx

Zwick Italia
www.zwickroell.it

Zwick Polska
www.zwick.pl

Zwick China
www.zwick.cn