

Testing of Plastics and Rubber

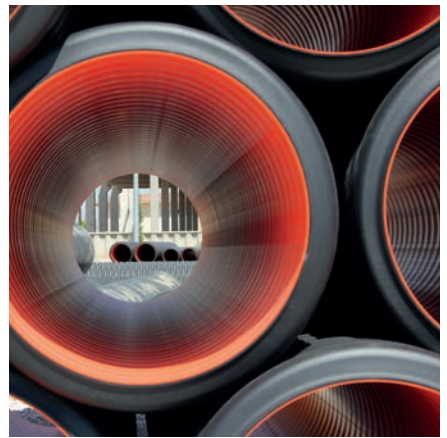

BB 269.2.0220

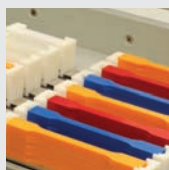
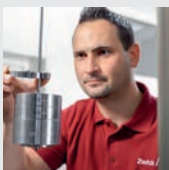
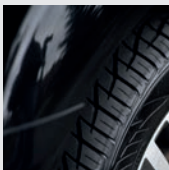

1 ZwickRoell Group

Content	Page
1.1 With passion and expertise	3
1.2 Your dependable partner for polymer testing	4

2 Plastics testing

Content	Page
2.1 Application overview - plastics	5
2.2 Molding materials and plastic products	6
2.3 Testing pipes	9
2.4 Testing films and sheet materials	10
2.5 Testing welded and glued joints	11
2.6 Testing soft foams	12
2.7 Testing hard foams	13
2.8 Component testing	14

3 Rubber testing

Content	Page
3.1 Application overview - rubber	15
3.2 Materials testing on rubber and elastomers	16
3.3 Testing dampers and bearings	17
3.4 Testing tires	18
3.5 Testing seals	18

4 Products and services for plastics and rubber testing

Content	Page
4.1 Dimensional measurement	19
4.2 Specimen preparation	20
4.3 Electro-mechanical testing machines	22
4.4 Servo-hydraulic testing machines	25
4.5 Temperature chambers	26
4.6 Creep testing machines	27
4.7 Pendulum impact testers	28
4.8 Rebound resilience testers	32
4.9 High-speed testing machines / drop weight testers	33
4.10 Extrusion plastometers	34
4.11 HDT and VST instruments	36
4.12 Robotic testing systems	38
4.13 Hardness testers	40
4.14 testXpert III – the new software generation for materials testing	42
4.15 Load cells	43
4.16 Specimen grips	44
4.17 Extensometers	45
4.18 Modernization of materials testing machines	46
4.19 Service from start to finish	47

5 Specimen shapes and standards overview

Content	Page
5.1 Specimen shapes, specimen dimensions and cutting dies	48
5.2 Standards and testing equipment	52

1.1 ZwickRoell – with passion and expertise

“Passion in customer orientation.”
If anyone asks about our corporate philosophy – that is our reply!
The fact that over a third of our employees are engaged in service and support shows that these are far from being empty words.

As a family-run concern with a tradition stretching back 150 years, we place great value on honesty and fairness. Over the years an ethos of close collaboration based on mutual trust between our partners, suppliers and customers has evolved, something that we all value highly.



Fig. 1: The Innovation Center at ZwickRoell headquarters in Ulm, Germany

The basis of a successful partnership: innovative employees, innovative products!

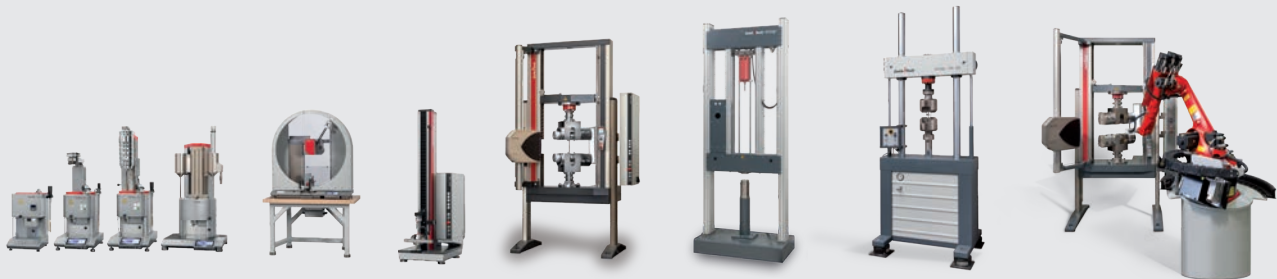

Always at your service

Over 1,100 people work at our headquarters in Ulm. Most of them have been with us for years – decades even. Their knowledge, ability and commitment are what lies behind the worldwide success of the ZwickRoell Group.

Today, we are present in over 50 countries around the world.

The right solution

Whether for static materials testing or the various forms of fatigue testing – we have the right solution. Products for hardness testing, solutions for impact testing, solutions for melt index determination.

And for that rare occasion when we don't have a standard solution to fit, our experts will find one – from the smallest adaptation right through to a fully automated testing system or a test stand for special purposes.

1.2 ZwickRoell – your dependable partner for polymer testing

System-based testing solutions

For over 60 years ZwickRoell has been developing testing machines and instruments for tests on plastics and rubber. Generations of researchers, developers and quality assurance specialists have achieved success using ZwickRoell testing equipment, relying on the accurate test results, the highly advanced measuring methods and the high availability guaranteed with ZwickRoell products.

Our comprehensive range of testing equipment is a product of our experience and commitment backed by close collaboration with our customers, while our varied product ranges offer a tailor-made solution for every application.

For occasional tests, as performed in goods incoming inspection, for example, ZwickRoell has very simple, cost-effective testing equipment. Production and quality control require robust, reliable testing equipment which can be tailored precisely to a testing situation and will then carry out this task in full compliance with standards and with a high level of repeatability, day in, day out, year in, year out. Materials research calls for a wide applicational range, achieved through a modular, system-based approach to attaching varied specimen holders and sensors.

A by-product of this modularity is that our testing machines can easily be retrofitted for new types of test many years into the future.



Fig. 1: Application lab at ZwickRoell in Ulm.

Specialists & standards

ZwickRoell has over 100 employees engaged in developing testing machines, instruments and software packages in line with the requirements of modern standards.

Specialists in our Applications Test Laboratory test new products and carry out tests for customers, at the same time verifying the suitability of the equipment for the types of test for which it is required.

Participation in various standards committees, including those relating to testing machines, plastics and fiber composites, means that several of ZwickRoell's employees are closely involved in the development of standards at both national and international level.

Product quality

Testing machines used to test brittle materials are subject to stringent requirements with regard to quality of drive and guide components, axiality and stiffness. ZwickRoell testing machines feature impressively high product quality.

Modern production methods, experienced employees

At ZwickRoell's Ulm plant the latest manufacturing techniques are employed in 7000 m² of production area. Modern machinery plus assembly by a competent, highly experienced workforce ensures consistently high quality. Many of our employees have been with the company for years; in some cases they are the second or third generation of their family to work at ZwickRoell.

Calibration – a particularly important requirement

All testing equipment is calibrated in accordance with current ISO standards before it leaves ZwickRoell's manufacturing premises, ensuring measurement accuracy of all force & position transducers.

Reliable test results

A quality that you can trust: Your testing results obtained with ZwickRoell testing equipment are accurate, reproducible, repeatable and traceable.



2.1 Plastics testing

One of ZwickRoell's particular strengths lies in the characterization of molding materials as specified in standards such as ISO 10350 (single-point data), ISO 11403 (multi-point data) and ISO 17282 (design data). Many of these results are obtained using ZwickRoell testing equipment and are made available by members of the CAMPUS group via their website at: www.campusplastics.com

Another key area is the wide realm of product and component testing. Here specimens are taken from finished products. Sections of the product are tested or the entire finished product is subjected to mechanical loading to test its operation. Items tested include plastic films and packaging, profiles, plastic pipes, hard and soft foams, as well as the wide field of testing complete seats.

2.1 Application overview



Testing machines up to 5 kN



Testing machines up to 250 kN



Temperature chambers



Robotic testing systems



Creep testing machines



Fatigue testing machines



High speed testing machines



Drop weight testers



Pendulum impact testers



Extrusion plastometers



HDT and VST



Hardness testers

Fig. 1: ZwickRoell testing equipment for materials and components. The range of application includes creep tests, quasi-static testing, dynamic methods, high-speed tensile tests, impact testing, hardness and flow-rate determination (melt index).

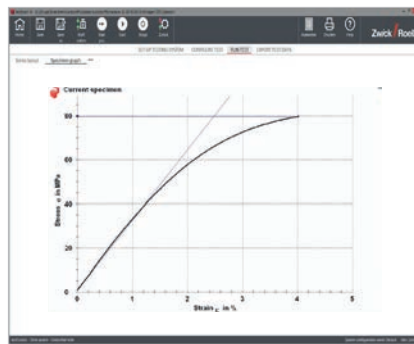
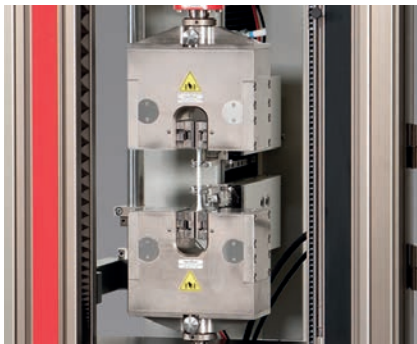

Fig. 1: Tensile test to ISO 527-2 with tensile modulus determination (moulding material characterization)

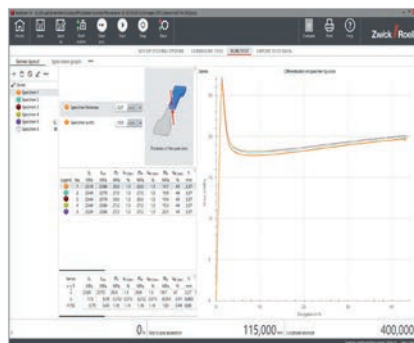

Fig. 2: Tensile test, e.g. to ASTM D 638. (quality control)

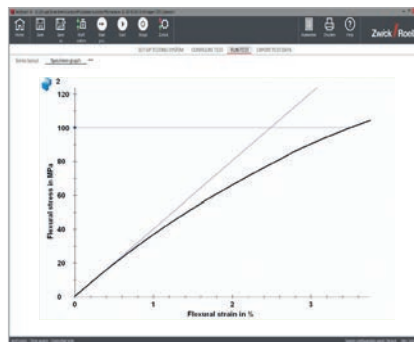
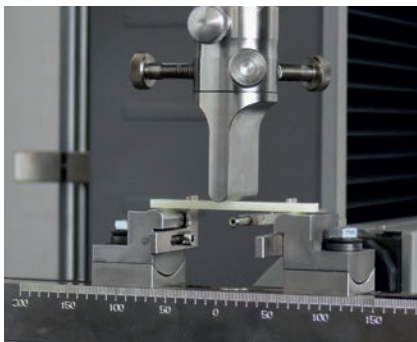

Fig. 3: Three-point flexure test at room temperature to ISO 178 or ASTM D790



Fig. 4: Easy changeover from tensile to flexure via mechanical slots and setting gages

2.2 Testing of molding materials and plastic products

A key aspect of the characterization of molding materials is inter-laboratory comparability of test results. Specimen production, specimen shapes and test sequences are all specified in detail, with exacting demands on both repeatability and reproducibility.

In quality control the change in measured values over a period is the basic standard of evaluation. Here it is more important for the measuring equipment to permit a high level of repeatability, even if reproducibility may be limited. This often simplifies machine design from a technical point of view.

Tensile tests

ZwickRoell has an optimum solution for every application. Parallel-clamping specimen grips and high-resolution extensometers for molding-material characterization; mechanical specimen grips and long-travel extensometers for quality control when no tensile modulus is required.

Flexure tests

Flexure fixtures must be aligned very accurately to ensure the specimen is loaded in the required way. Setting-gages and centering stops simplify this operation, while a highly practical T-slotted system allows the flexure test kit to be mounted in the tensile specimen grips quickly and aligned securely.

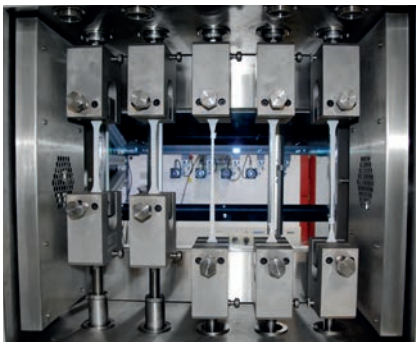

Fig. 1: Creep test under tensile loading, ISO 899-1, ASTM D 2990

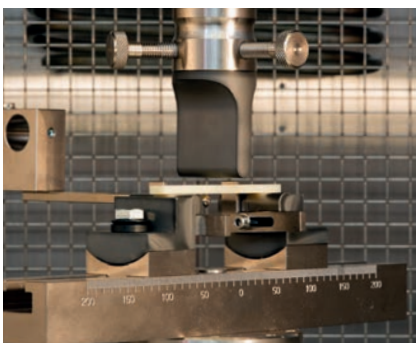
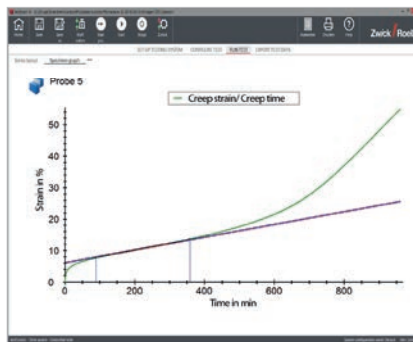

Fig. 2: Creep test with flexural loading, ISO 899-2

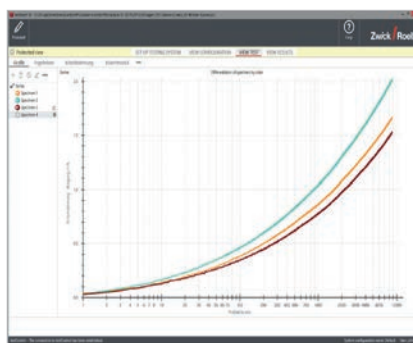

Fig. 3: HDT test to ISO 75-2: specimen are heated at a constant rate in liquid transfer medium

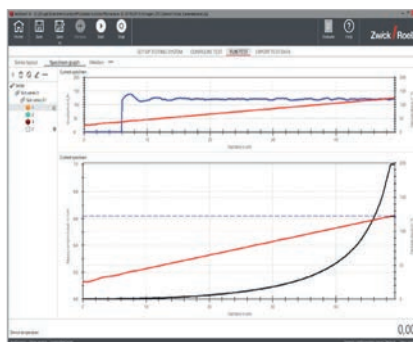
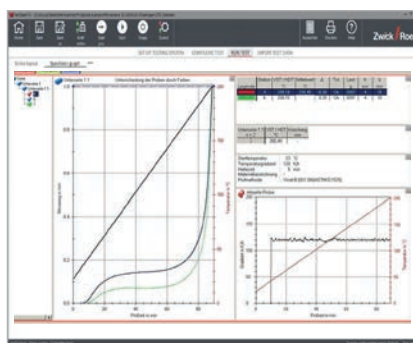

Fig. 4: VST test to ISO 306: measurement of penetration by a needle under load



Creep tests

These tests are carried out under constant static load. Typical results in individual tests are strain-time curves and creep modulus-time curves. Multiple tests can be used to generate isochronic stress-strain curves or fracture curves.

Test duration is frequently 1000 hours or more. For this reason special creep testing machines optimized for this purpose are used. Key parameters in addition to test time are temperature, humidity and retention in media. Creep methods are usually tensile tests or flexure tests. A test arrangement for compressive loads is furthermore specified in ASTM D2990.

HDT and VST

To determine Heat Deflection Temperature (HDT) and Vicat Softening Temperature (VST), specimens are subjected to a defined load at a constant rate of temperature rise. The result is the temperature at which a specified deformation or penetration is achieved. Creep characteristics can additionally be determined without change of temperature using an HDT test arrangement.

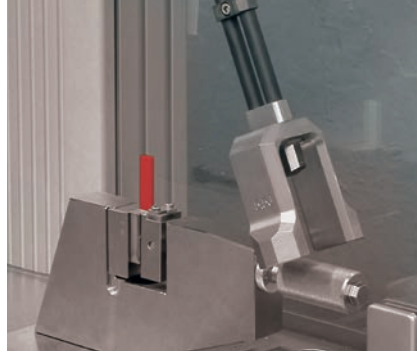
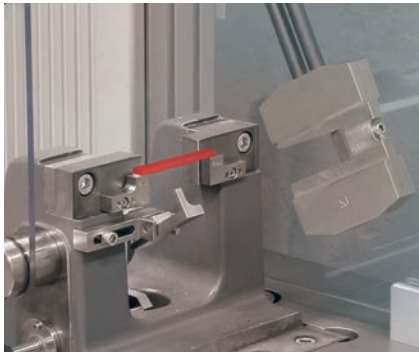

Fig. 1: Conventional impact tests: left, Charpy; right, Izod

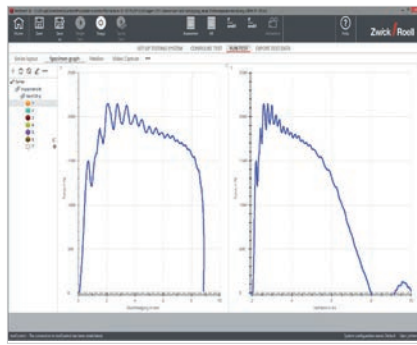
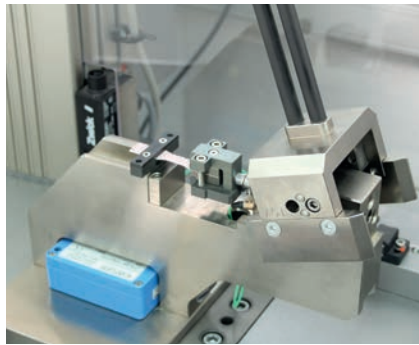

Fig. 2: Instrumented tensile impact test: the force sensor is located on the clamp

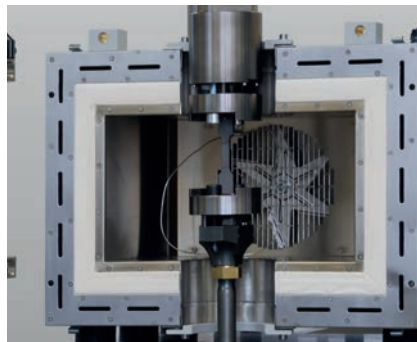

Fig. 3: The high-speed tensile test delivers tensile properties at elevated strain rates

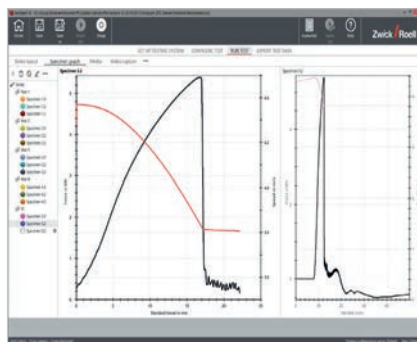

Fig. 4: Multi-axial impact test to ISO 6603-2 with force-travel recording

Impact tests

Pendulum impact, conventional

The result obtained from this test is resilience and a fracture type. The resilience is expressed as the energy required to break the specimen; this energy is measured via a rotary encoder on the pendulum axis. Pendulum sizes, impact speeds, specimen geometries and specimen holders are all specified exactly in the standards.

Pendulum impact, instrumented

By using a force sensor plus fast data acquisition to determine the force-travel-time progression, additional data can be obtained. Results are maximum force and strain at break; fracture-mechanic characteristics and identification of the failure type are also possible.

High-speed tensile tests

To obtain data for component design, tensile tests are performed over a wide range of strain rates. Tensile impact tests performed with pendulum impact testers can provide data in the lower speed range, while higher speeds are attained on drop-weight testers and hydraulic high-speed testing machines (HTM).

Instrumented multi-axial impact tests

This test represents a multi-axial stress condition. A force sensor in the penetrator generates the measuring signal. The test is carried out on a drop-weight tester or in a high-speed testing machine.

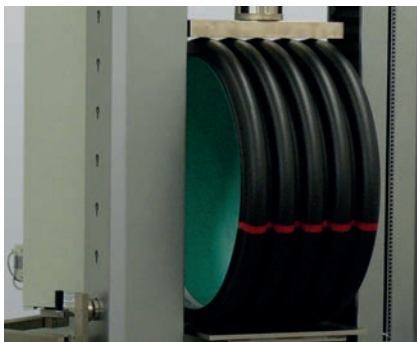

Fig. 1: Measuring ring stiffness, ISO 9969: ring deformation is measured on the internal diameter

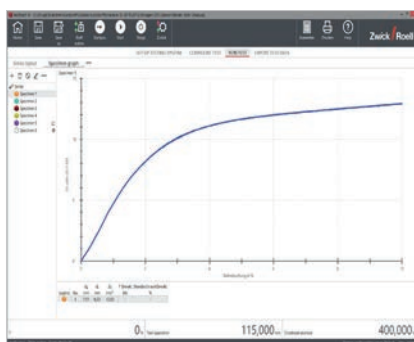

Fig. 2: Special displacement transducers are available for pipes up to 630 mm diameter

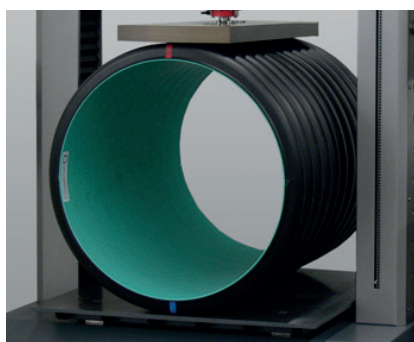
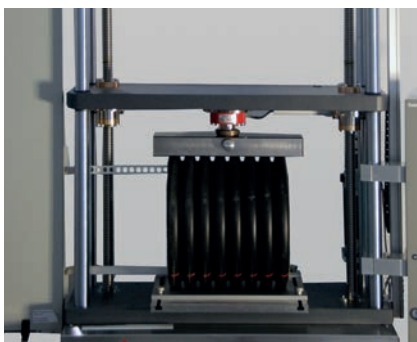

Fig. 3: Creep tests on pipe segments

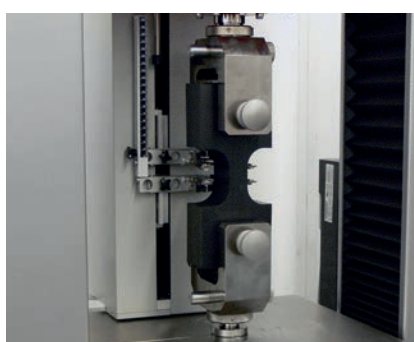

Fig. 4: Tensile test to ISO 6259: specimen shapes depend on wall thickness

2.3 Testing plastic pipes

Depending on the field of use and the type of pipe, widely differing types of test are involved and these are described in the relevant specifications. ZwickRoell can supply precision, standard-compliant equipment for mechanical tests.

Initial ring stiffness

This property characterizes the resistance of a section of a pipe to radial compressive forces. Measurement takes place at low pipe deformations of 3%.

Ring flexibility

The test arrangement is similar to that used for measuring ring stiffness; however, deformations of 30 % are used.

Creep test

Creep tests are used to determine the long-term behavior of sections of pipes under radial loading or in a flexure arrangement. A test duration of 42 days is usual; in individual cases much longer creep tests are also performed. Results include creep behavior and creep modulus.

Tensile test

To enable characterization of the pipe material, dumbbell specimens are machined from the pipe wall and subjected to tensile tests.

Strain hardening modulus

A new method to characterize slow crack growth (SCG) according ISO 18488 on PE pipe-grades.

Vicat softening temperature

Softening temperature can be an important property for pipes used for transporting hot substances.

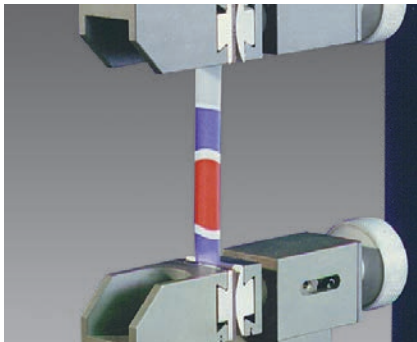
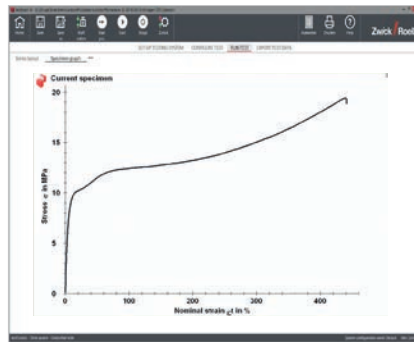

Fig. 1: Tensile test to ISO 527-3, ASTM D 882



2.4 Testing films and sheet materials

Tensile tests

Films and sheets up to 1 mm thick are tested using strips or dumbbell specimens. With strips the material elongation is usually nominal and is therefore determined via the travel of the pulling clamp; direct-measuring optical extensometers are used for dumbbell specimens.

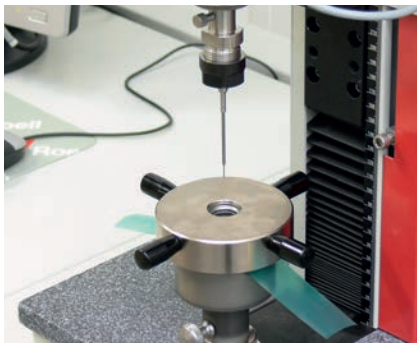
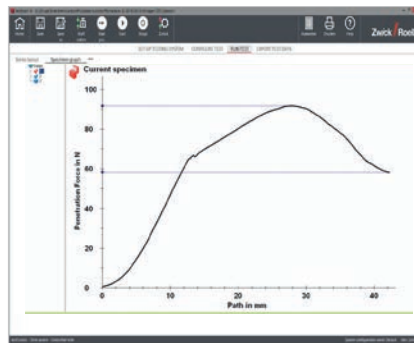

Fig. 2: Puncture test on films as per EN 14477 (Parker pen test)



Puncture tests

For packaging, loads applied by hard, pointed or angular objects are an important factor. The puncture test to EN 14477 measures this behavior using a 0.8 mm-diameter point. This is also known as the 'Parker pen test'. A similar test is described in ASTM F1306; in this case the indenter is a ball 35 mm in diameter.

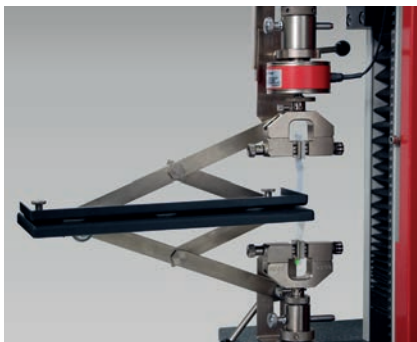
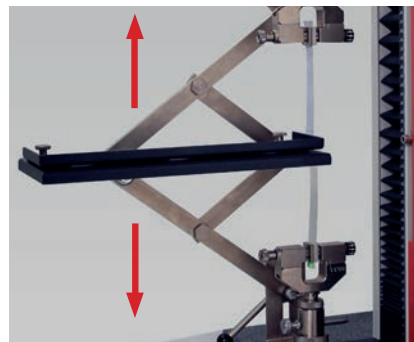

Fig. 3: 180° peel test; support maintains a constant separation angle



Tear-growth tests

Tear-growth strength refers to the resistance of a material to the propagation of a tear. The test arrangement is similar to that used for the tensile test, while the specimen is of the graves or angle type with a defined crack.

Separation of layers

With multi-layer films it is important to know the ply adhesion. To measure this, ply separation tests, mostly in the form of 180° separation tests, are carried out.

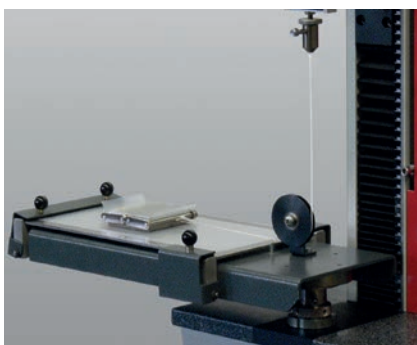
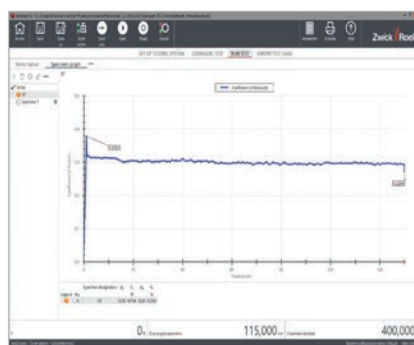

Fig. 4: Determining both, static and dynamic coefficients of friction (COF)



Determination of friction coefficients

Static and dynamic friction coefficients of flexible films can easily be measured on a static testing machine using a supplementary device. This test is defined in many standards.



Fig. 1: 90° peeltest to measure peel resistance

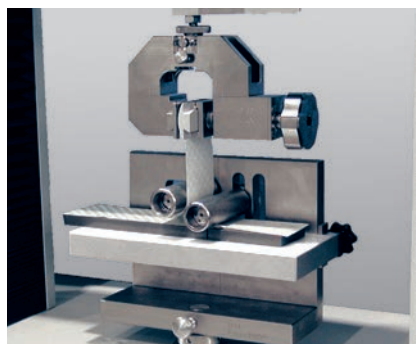

2.5 Testing welded and glued joints

Flexible materials

Peel resistance tests

Peel resistance is measured in the pull-off adhesion test. As this depends significantly on the peel angle, standardization has produced a whole range of test methods. ZwickRoell has test fixtures to suit each of these.

- 90° peel test
- 180° peel test
- Floating roller peel test
- Sealed seam test



Fig. 2: Testing the sealed seam on a yoghurt pot. The peel angle remains constant.

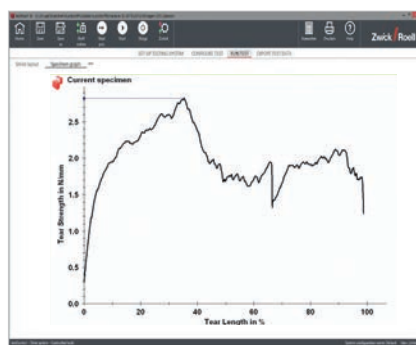

Initial adhesion

This property is determined for items such as adhesive labels and adhesive tapes. The initial adhesion is expressed as the maximum pull-off force.

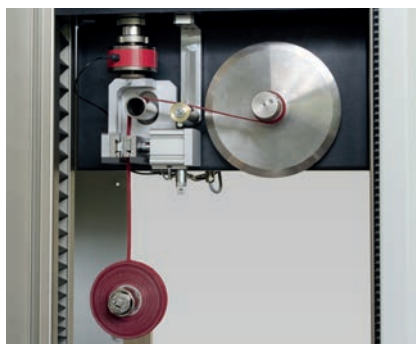

Fig. 3: Measuring unwinding peel force



Fig. 5: Floating roller peel test, ISO 4578

Stiff materials

Shear strength and tensile properties

The tensile properties of bonded joints are tested in adhesion test using butt joints, while their shear properties are determined in the overlap shear test.

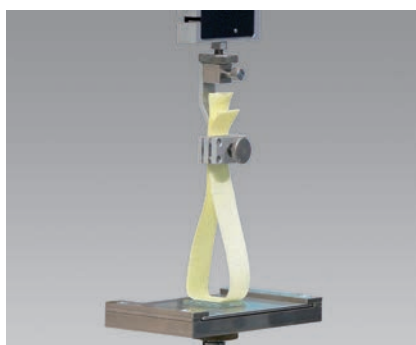

Fig. 4: Determining the initial tack of adhesive labels in the loop tack test to Finat FTM 9

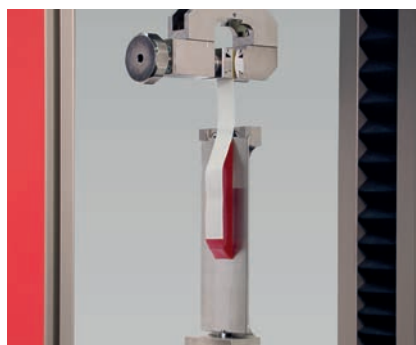

Fig. 6: 180° peel test as per EN 1939 and AFERA 4001

Energy release rate

Resistance to crack propagation is characterized via the energy release rate which reference to the crack surface. The DCB test arrangement is commonly employed, with crack propagation generated through crack opening (Mode I).

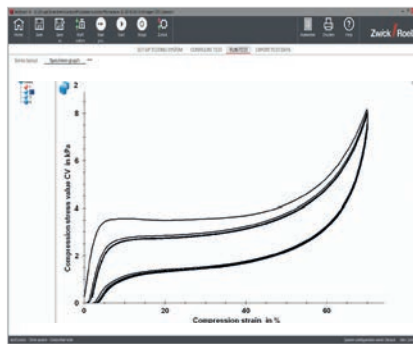

Fig. 1: Compression properties, compression stress value (ISO 3386, ASTM D 3574)

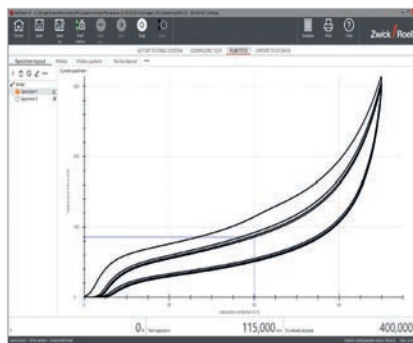
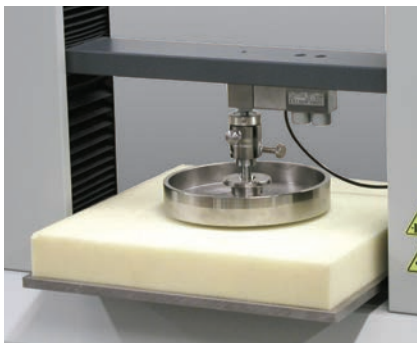

Fig. 2: Indentation hardness as per ISO 2439, ASTM D 3574

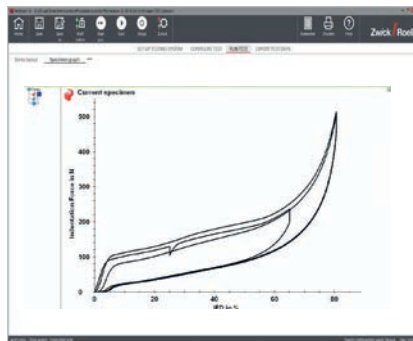

Fig. 3: Indentation hardness of molded foam parts (DIN 53579-1)

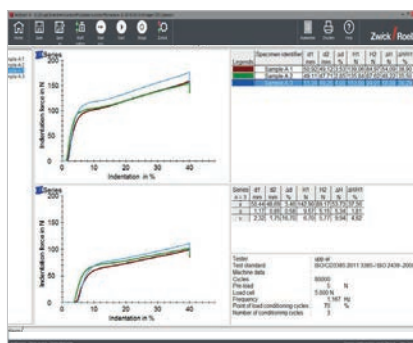
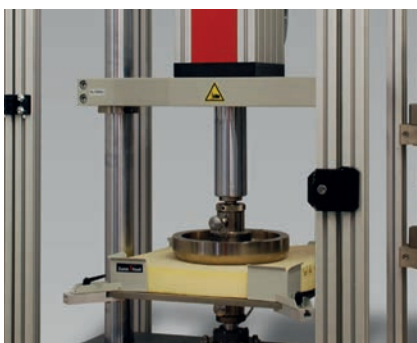

Fig. 4: Constant load pouncing test to ISO 3385: Test curves before and after cyclic loading

2.6 Testing soft foams

These foams are used for vehicle seat cushions, furniture, mattresses, as insulating material and for acoustic damping. Test methods are oriented to these uses.

Compression properties, compression stress value

A rectangular block specimen is subjected to closely cyclic compression loads between two flat, perforated compression platens in a specified sequence. The result is expressed in force or travel values which are recorded after a specified dwell time.

Indentation hardness

An indenter of defined shape and dimension (diameter 203 mm) is used to be indented into a foam block which is larger than the indenter.

Constant load pouncing

The test sequence consists of measurement of the indentation hardness and initial thickness, followed by load pouncing, e.g. with 80000 cycles, and re-measurement of indentation hardness and thickness. From these values the hardness loss and thickness loss are determined. This test is sometimes performed under special climatic conditions as well as under standard climates.

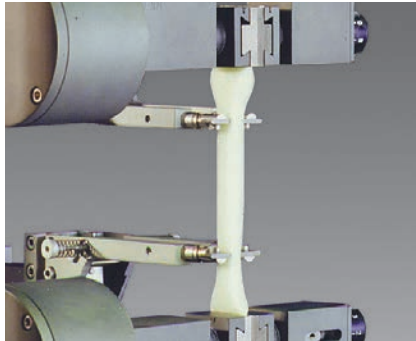
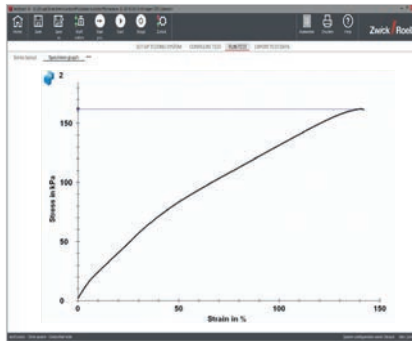

Fig. 1: Tensile test ISO 1798, ASTM D 3574



Tensile test

Tensile properties are determined on a dumbbell specimen. Strain can be measured using low inertia and friction type mechanical extensometers or with optical extensometers.



Fig. 2: Tear test ISO 8067

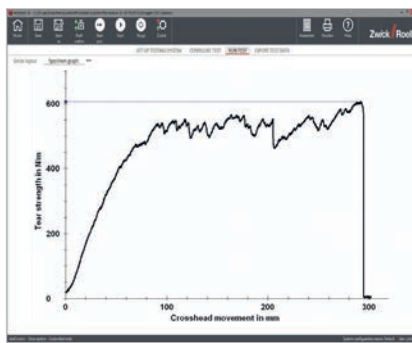

Tear test

This test is used to determine the tear resistance of foams. In contrast to the same type of tests in the field of rubber, specimen is charged in crack-opening mode, also known as mode I.



Fig. 3: Compression test to ISO 844, with and without direct travel measurement

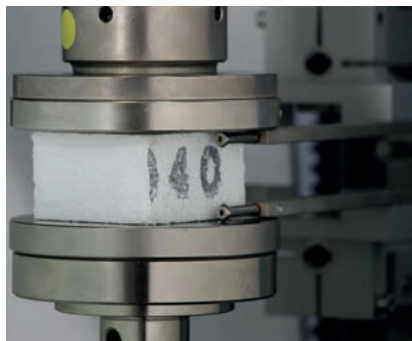

2.7 Testing hard foams

Hard foams are used for thermal and acoustic insulation, as core material for composites and as a substrate material, for example in road construction.

Measurements:

- apparent density
- tensile properties
- compression properties
- compression - creep
- flexural properties
- shear properties.



Fig. 4: Perpendicular tensile as per EN 1607

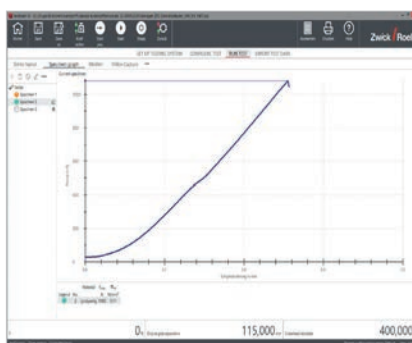

Fig. 5: Tensile test curve to ISO 1926

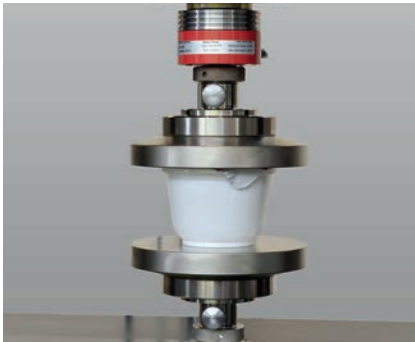

Fig. 1: Determining stackability of hollow packagings and drinks crates

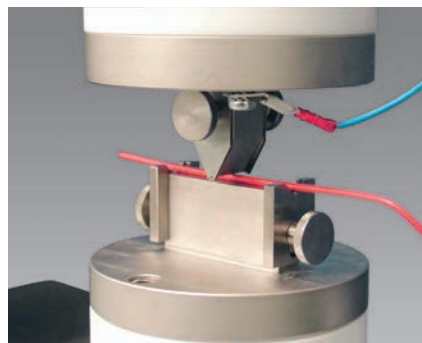
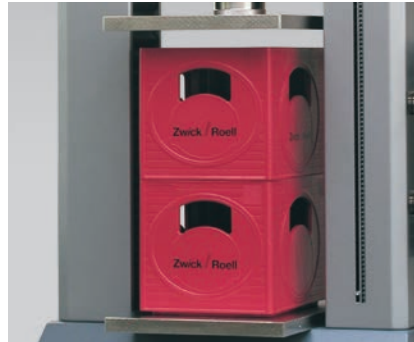

Fig. 2: Measuring the notch-resistance of cable insulation as per LV 112



Fig. 5: Determining operating forces



Fig. 3: Corner strength of a window frame



Fig. 6: Extraction tests on bottle corks

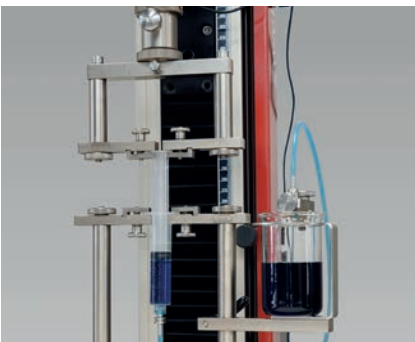

Fig. 4: Function test on hypodermics



Fig. 7: Function test on safety screw-closures

2.8 Component testing

The properties of a component or structural element cannot always be predicted exactly from the material properties. Components are therefore tested in typical loading situations. This enables strength and deformation characteristics to be determined and calculation methods validated.

In addition to a wide range of standard fixtures such as T-slotted tables, bending beams and hold-down clamps, ZwickRoell testing machines offer numerous options for recording and documenting test results. Examples include:

- recording a video sequence synchronously to the measured-value curve
- recording contact and switching states
- recording changes in electrical properties.

Function test

The key attribute of a product is its ability to function.

Items measured include the stacking height of packaging or the operating force required to open a drinks can, remove the lid of a food container or operate a pump mechanism.



3 Testing rubber

ZwickRoell's active involvement in the field of rubber and elastomer testing stretches back decades. The testing machines have assisted in many technical developments and remain today an important research and development instrument.

Key areas of these tests are materials characterization using standard specimens and measurements on specimens sampled from compon-

ents such as tires, shock absorbers, conveyor belts, belts, seals and other technical products, together with condoms, gloves or shoe soles.

ZwickRoell's range includes static and dynamic materials testing machines for tensile, compression, flexure and torsion loading; hardness testers, abrasion testers, rebound resilience testers as well as fixtures for determining compression set.

3.1 Application overview



zwickiLine testing machines



ProLine testing machines



AllroundLine, temperature chamber



Robotic testing system



Test rig



Torsion testing machines



Fatigue testing machines



Compression set



Abrasion test instrument



Rebound resilience testers



Analog hardness testers



Digital hardness testers

Fig. 1: ZwickRoell rubber-testing equipment



Fig. 1: Tensile test to ISO 37, ASTM D 412

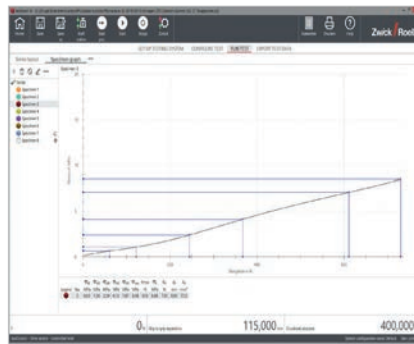

3.2 Materials testing on rubber and elastomers

Tensile tests

The tensile test is one of the most frequently used tests. It supplies several properties and is usually performed on dumbbell specimens or ring specimens.

Tear tests

This test characterizes the behavior of a notched, i.e. damaged material. Three different specimen types are available:

- trouser-type specimen
- angle-type specimen
- crescent-type specimen.

Compression tests

This test is used to determine compression moduli. The specimen is cyclically loaded four times in accordance with ISO 7743. During the fourth loading cycle compression moduli are determined at specified reference points.

Compression set

This is an important property where seals are concerned. It is determined by measuring the thickness loss which occurs under a specified deformation, possibly at higher temperature, after a defined period.

Shear tests

Shear characteristics are usually measured via double-lap shear, sometimes also in quadruple shear, in which four rubber blocks are sheared. The shear modulus is measured after multiple cyclic loading.

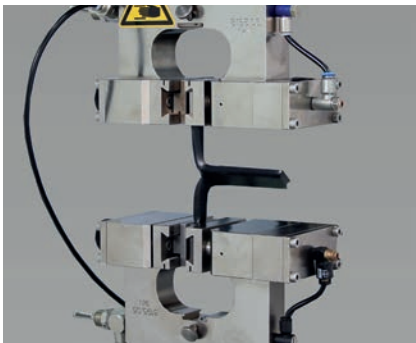

Fig. 2: Tear test on a trouser-type specimen as per ISO 34-1

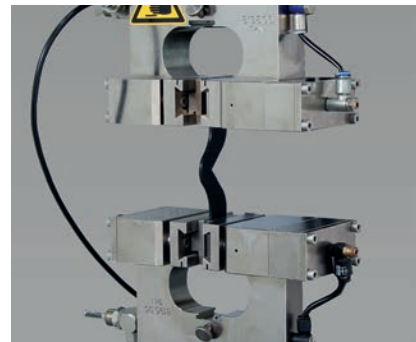
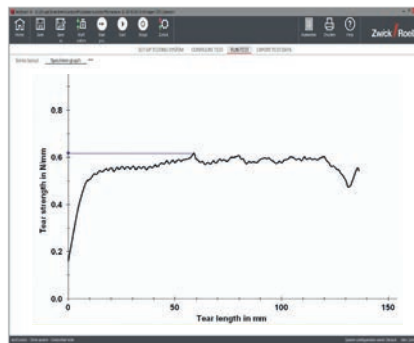

Fig. 3: Tear-growth test on an angle-type specimen to ISO 34-1

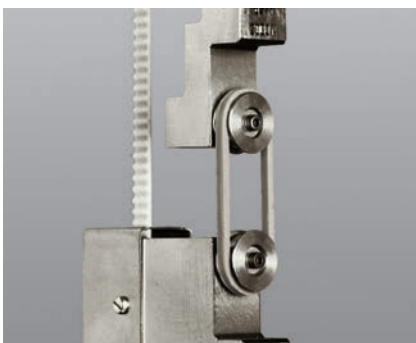
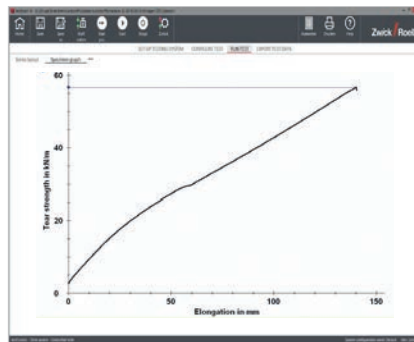

Fig. 4: Tensile test on ring specimens to ISO 37, ASTM D 412

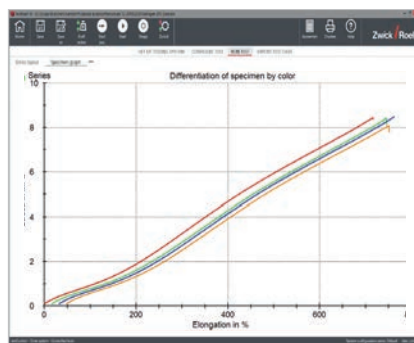



Fig. 1: Abrasion resistance, ISO 4649

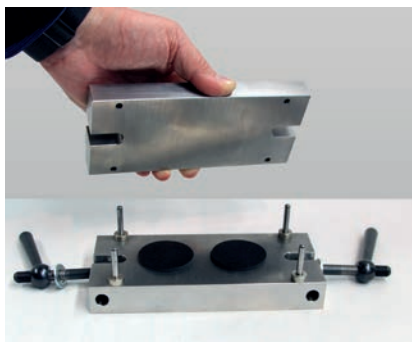

Fig. 5: Measuring compression set



Fig. 2: Shore A hardness, ISO 48-4



Fig. 6: IRHD hardness of an O-ring



Fig. 3: Testing dampers...



... and bearings

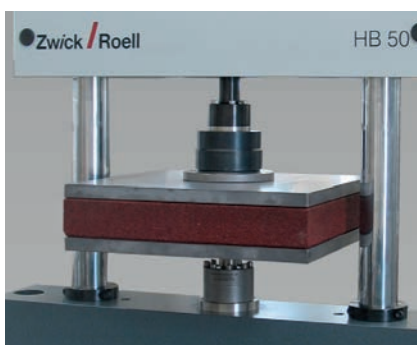

Fig. 4: Dynamic tests on acoustic floor panels and end-cushioning parts



Abrasion test

This is a comparative test. First the abrasion is determined on a standard reference elastomer under specified conditions by weighing. The result for the rubber being tested is then stated in relation to the reference elastomer.

Hardness

Measurements on rubber are usually performed as per IRHD or Shore A; in special cases the Pusey & Jones method is used.

Rebound resilience

This dynamic property is measured using a Schob pendulum.

Viscoelastic properties

The specimen is loaded by means of forced vibrations. The storage modulus and loss modulus are determined from the resulting force signal. The test may be performed over a wide frequency range (frequency sweep) and over a wide temperature range.

3.3 Testing dampers and bearings

Used frequently in automotive construction, damping elements consist of elastomers and are often connected to metal supports.

Viscoelastic properties are measured using servo-hydraulic testing machines in a wide range of frequencies and temperatures.

Static testing machines are used when maximum load and deformation states are involved, or when defined in-service situations must be recreated under laboratory conditions.

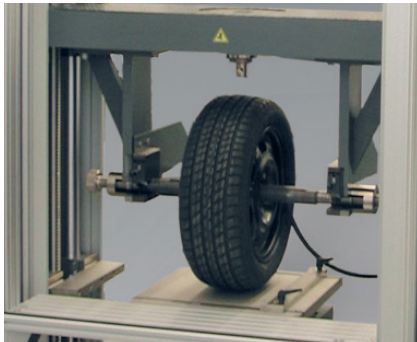

Fig. 1: Testing the ride and handling characteristics of a passenger-car tire

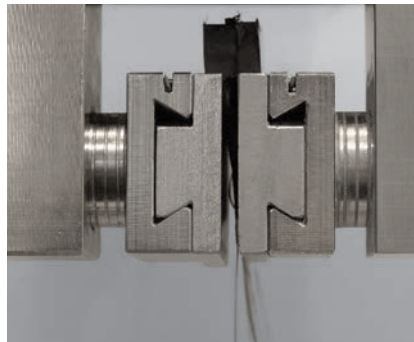

Fig. 4: Pull-out test on tire cords

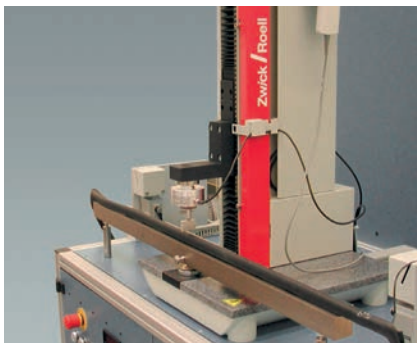

Fig. 2: Measuring the locating force of a car side window into a rubber seal extrusion

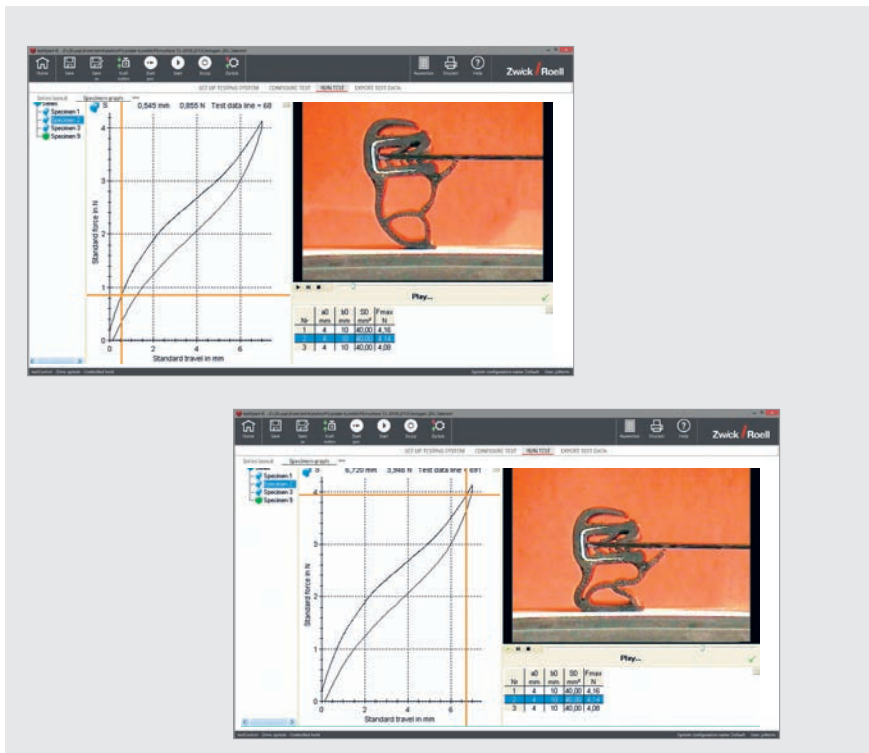
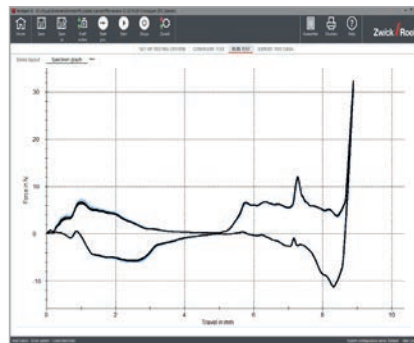

Fig. 3: Deformation of a seal extrusion. Video image and force-travel diagram are synchronized exactly for easy-to-understand data.

3.4 Testing tires

The individual component parts of a tire, such as rubber, textile carcass, tire cords and steel belt, are tested individually using the classical methods.

The bond between rubber and metal or textile cords is a major factor in the durability and quality of a tire. This property is determined by means of pull-out tests and adhesion tests.

Testing the performance characteristics of complete tires may involve a static test to measure tire deformation under complex loadings or a dynamic cyclic test.

3.5 Testing seals

Seal extrusions and profiles must reliably fulfil defined functions over a long period.

ZwickRoell can supply the standard test fixtures required for these test and manufactures fixtures designed for specific profiles.

During development of complex seal extrusions, information regarding their deformation behavior can play a critical part. This is where ZwickRoell's Video Capturing Plus comes into play.

Using a camera, a sequence of images is recorded parallel to the test. Integrated hardware synchronization enables test data and video image to be synchronized exactly. When the video is replayed the associated measuring point is shown in the curve graphic.

4 Products and services for plastics and rubber testing

4.1 Dimension measurement

Exact, repeatable determination of the linear dimensions of the specimen has a significant impact on test-result reproducibility.

Methods for determining linear dimensions are specified in various standards in accordance with material properties and the dimensions to be determined.

Vernier calipers

The use of Vernier calipers is permitted for measuring dimensions ≥ 30 mm on plastics and rubber (ISO 178, ISO 4648, ASTM D 3767, DIN 53534), and for dimensions ≥ 10 mm on hard foams (DIN 53570).

Ratchet micrometer

These micrometers feature constant measuring force and are used to measure dimensions ≥ 0.25 mm on rigid and semi-rigid plastics.

Electronic Vernier calipers and micrometers can be connected to a PC via an interface and multiplexer. Multiplexers are available for 2, 3 or 6 measuring devices.

Thickness measuring device with constant measuring-force

These measuring devices are used to determine the linear dimensions of rubber, elastomers, soft plastics, flexible foams, thin sheet materials and films.

The contact pressure exerted on the specimen by the thickness measurement device determines the accuracy of the measurement. Various standards specify the shape and area of the sensor and support contact surfaces, together with the weight to be applied. ZwickRoell supplies ready-for-use sets consisting of contact elements and weights for rubber testing and film testing.



Fig. 1: Digital vernier caliper



Fig. 2: Ratchet micrometer

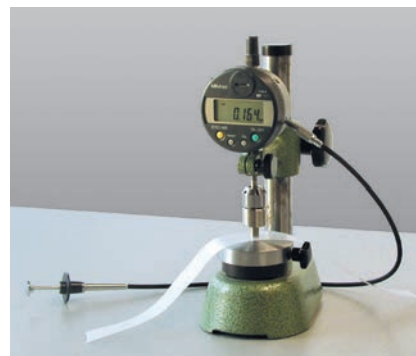

Fig. 3: Thickness measuring device with constant measuring force

Requirements of standards for measurements by use of a micrometer or an automatic cross-section measuring device

Standard	Material	Test type	Measurement of	Reading req.
ISO 527-1	Rigid and semi-rigid plastics	Tensile	Thickness, width	≤ 0.020 mm
ASTM D 638	Rigid and semi-rigid plastics	Tensile	Thickness, width	≤ 0.025 mm
ISO 178	Rigid and semi-rigid plastics	Flexural	Thickness, width	≤ 0.010 mm
ASTM D 790	Rigid and semi-rigid plastics	Flexural	Thickness, width	≤ 0.010 mm
ASTM D 374	Plastic sheet and film	General	Thickness $> 0,25$ mm	≤ 0.010 mm
ISO 1923	Rigid cellular plastics	General	Dimensions ≤ 10 mm	≤ 0.05 mm

4.2 Specimen preparation

Standard specimens of thermoplastic and thermosetting molding materials are produced by injection molding or compression molding. During this process the material properties are influenced considerably by manufacturing parameters such as pressure, temperature and flow-rate.

Specimens are removed from sheets or components by machining, for example as specified in ISO 2818.

An overview of established specimen shapes can be found at the end of this document.

Notching

Manual and motorized notching instruments are available for impact test specimens.

Manual notching plane

Manual, but very convenient. The manual notching plane produces good notch results and is designed for average specimen volumes. Four specimens are notched per pass.

ZNO automatic notch-cutting machine

The motor-driven notch-cutting machine produces notches using a single-tooth milling cutter. Depending on specimen thickness, 12 specimens may be milled simultaneously. The quality of the notches is optimized for each material by separate adjustment of the feed rate and cutting speed.

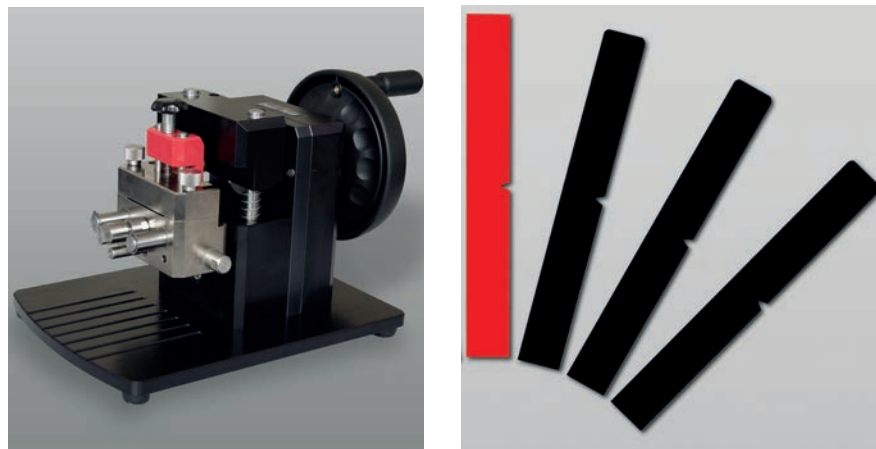

Fig. 1: Manual notching plane for reliable production of single and double notches. Cutting feed and advance are linked, while remaining width is set via a limit switch stop.

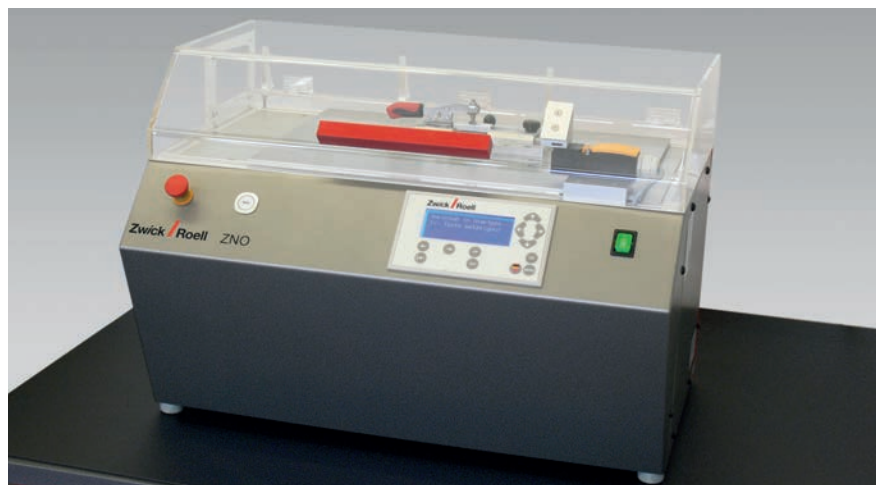

Fig. 2: The ZNO automatic notch-cutting machine allows single or double notches for specimens to be milled conveniently in bundles

Standard	Shape A	Shape B	Shape C	Shape D
ISO179-1	single or double notch	single or double notch	single or double notch	-
ISO180	single notch	single notch	-	-
ISO8256-1	double notch	-	-	-
ASTM D 256	single notch	-	-	-
ASTM D 6110	single notch	-	-	-
DIN 53435	single notch	-	-	single notch
Sketch				
Radius of notch root	0.25 mm ± 0.05 mm	1.00 mm ± 0.05 mm	0.10 mm ± 0.02 mm	0.25 mm ± 0.05 mm

Fig. 3: Overview of notch shapes

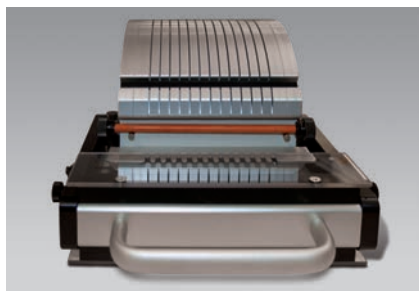

Fig. 1: Up to 10 specimens can be cut out simultaneously with the strip-cutter. The cut edges are exactly straight, parallel and notch-free.

Strip-cutter for film materials

It is important when producing strip specimens from film materials for static tensile tests that the cut is clean and notch-free and the strips are cut out exactly straight and parallel. To use this strip cutter a piece of film approximately 180 mm wide and 300 mm long is fastened to the convex cutting bed.

The cutting tool consists of 11 blades, which cut all strips simultaneously in one pass.

Specimen dimensions

Length: approx. 230 mm
 Width: 10 or 15 mm
 Thickness: 5 to 900 µm

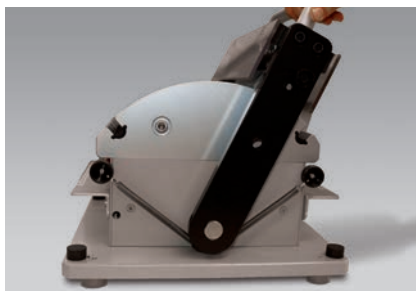

ZwickRoell cutting presses and cutting dies

For producing specimens from rubber or soft plastics, ZwickRoell has a large range of cutting dies for standardized and special specimen shapes. Current versions are listed in the tables in the section headed „Specimen shapes“.

Advantages of cutting dies:

- easy blade change
- mechanical ejection system (no injury hazard from sharp cutting edges)
- multiple re-sharpening possible
- cutter and ejector system are separate components – only blade needs to be replaced in the event of wear.



Fig. 2: 7101 eccentric cutting press with centering spigot for circular specimens



Fig. 3: ZCP020 bent-lever cutting press for all specimen shapes



Fig. 4: 7108 pneumatic cutting press for all specimen shapes

Reference	7101 ¹⁾	ZCP020	7108
Application	circular specim.	all shapes	all shapes
Max. applicable load	5 kN	20 kN	35 kN
Push rod stroke	25 mm	41 mm	30 mm
Max. distance push rod-table	65 mm	155 mm	70 mm
Adjustment of push rod stroke	12 mm	25 mm	-
Adjustment of table elevation	-	-	70 mm
Projection	46 mm	125 mm	110 mm
Anvil table	swiveling	250 x 250 mm	350 x 215 mm
Compressed air supply	-	-	6 bar
Net weight	40 kg	55 kg	75 kg

¹⁾ Cutting dies can be used for ring-shaped specimen up to a diameter of 80 mm, square-shaped specimen up to 75 mm and rectangular and dumbbell shaped specimens up to a size of 160 x 30 mm

4.3 Electro-mechanical testing machines

zwickiLine - small footprint, big range of application

These high-quality single-column load frames are easy to operate and are specially designed for test loads up to 5 kN.

The short versions are used for flexure tests or function tests, while long load frames are ideal for tensile tests, for example on extendable polymers, plastic films or rubber.

ProLine – the machine range for standard tests

Do you carry out incoming goods inspection or quality assurance in accordance with established standards? Do you need to measure force and deformation or strain? Then ProLine is just what you need. These load frames are equipped with guide columns and lead-screw drives and are available in load capacities from 5 kN to 100 kN. A comprehensive range of specimen grips, test fixtures and mechanical or optical extensometers are available.

Allround Line – extra convenience for advanced testing requirements

The table-top AllroundLine models feature two columns manufactured from patented aluminium extrusions. They are light, feature high flexural stiffness and function as both lead-screw guide and lead-screw guard. AllroundLine table-top models can be fitted with support legs to enable positioning of the test area at the optimum height for the operator or the application.



Floor-standing AllroundLine models feature a load frame with two or four guide columns. The extremely stiff load frame construction ensures optimum conditions for exact alignment of test axes, while the load frame can be equipped with one or two test areas. For component testing the base crosshead can be in the form of a mounting plate, while for torsion tests the load frame is equipped with a torsion drive with testControl II plus appropriate sensor system.

testControl II – perfect measurement and control

testControl II is 'Made by Zwick-Roell' and is ideally aligned to the requirements of plastics and rubber testing. Signals from the sensors are scanned at a very high rate and processed at up to 2000 Hz in testXpert III. Add to this 24-bit signal resolution, and the result is extremely high test-result accuracy

and reproducibility over the entire speed range. The innovative testControl II electronics set the standard regarding safety technology, performance, quality, control and drive technology.

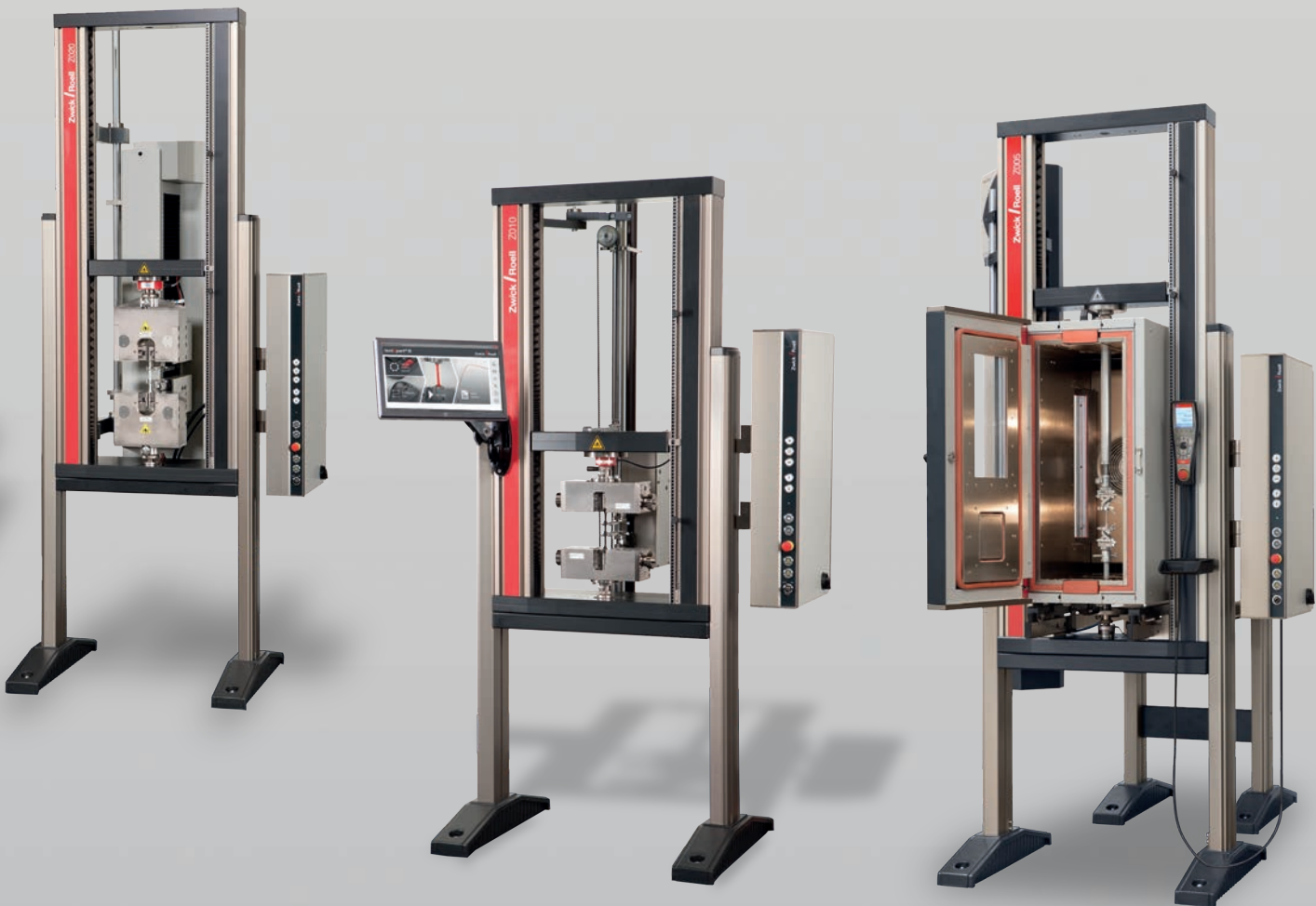

Load frames for soft foam testing

Optimized load frames for testing large slabstock or molded foam items such as seat cushions and mattresses offer a considerable advance in convenience and flexibility.

C-shaped load frame

This design is suitable for testing large foam items. Table leaves can be folded up to provide a very large support surface, while the test area is accessible from three sides, allowing rapid, highly convenient operation. The use of adapter pieces enables these load frames to be used additionally for tensile and tear-growth tests.

Additional test area

For this a standard load frame is mounted on a base frame, creating an additional test area for testing large molded foam components.

Load pounding machine for static and dynamic testing

With its fast electro-mechanical drive, this machine is a true all-rounder. Both, constant load pounding (e.g. to ISO 3385 or in accordance with an automotive industry test method) and static tests including compression characteristics and indentation hardness can be carried out with this type of machine.



Fig. 2: Testing foam components in the third test area below the load frame



Fig. 1: Specific testing machines for soft foams: (left) combined load pounding and indentation hardness testing machine; (right) C-shaped load frame for large and small foam parts.

4.4 Servo-hydraulic testing machines

ZwickRoell's servo-hydraulic testing machines possess an extremely stiff load frame which is fatigue-resistant right up to nominal load. They feature fast, precise data acquisition combined with intelligent control of all test sequences.

Dynamic applications

Typical range of application includes tensile, compression and flexural cyclic load tests on plastics, measuring the dynamic behavior of rubber mountings, air-springs and elastomer dampers, plus fatigue tests and dynamic peel tests on adhesive joints.

The right load frames for each application

Different load frames are used according to application. The HC model is a table-top machine featuring a high degree of frame stiffness. The HA model has a bottom-mounted testing actuator and height-adjustable crosshead, while the HB model features a top mounted actuator and height-adjustable crosshead.



Fig. 1: Servo-hydraulic testing machines for rapid cyclic loading

4.5 Temperature chambers

ZwickRoell temperature chambers for installation in static and dynamic testing machines enable testing over a wide standard temperature range from -70 °C to +250 °C. Heating is electrical, liquid nitrogen is used as a coolant.

High-quality control

Control is provided by a high-quality temperature-controller. Temperature sensors record the temperature at the fan and optionally in the vicinity of the specimen also.

Easy configuration change

The temperature chambers are mounted on rails for easy insertion

and withdrawal, while T-slotted removable segments allow withdrawal with no need to unmount the specimen grips.

Extensometer solutions

A lateral port, optionally with a heated pane, allows optical or mechanical extensometers to be used.



Fig. 1: AllroundLine testing machine with temperature chamber in testing position. Extension measurement is via a side port.



Fig. 2: The temperature chamber can be slid out on rails



Fig. 3: Optional magazine for preconditioning of specimen.

4.6 Creep testing machines

Measurement of the creep behavior of plastics under constant load is carried out via tests to ASTM D2990 (tensile and flexure) and ISO 899-1 (tensile) or ISO 899-2 (flexure).

Load frames with multiple test axes enable simultaneous testing of several specimens by means of shock-free electro-mechanical load application.

In all types of test, extension or deformation measurement is performed optically using a video camera, with the ability to have several specimens in the field of view of one camera.

High-quality temperature or climatic chambers are used to condition specimens during the tests, which are often of lengthy duration.

These electro-mechanical creep testing machines can additionally be used for static tensile, compression, flexural and stress relaxation tests in a speed range up to 100 mm/min.



Fig. 2: Electro-mechanical creep testing system with 6 stations and temperature chamber

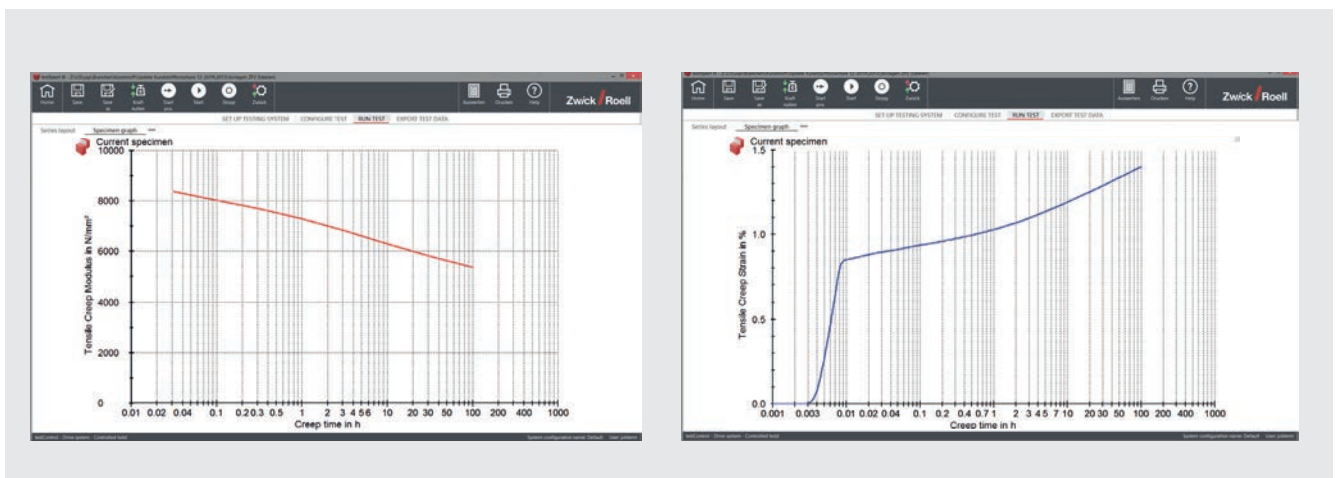

Fig. 1: Typical evaluation: creep modulus-time diagram (left); creep-time diagram (right)

4.7 Pendulum impact testers

HIT pendulum impact testers conform exactly to the requirements of international standards right down to the smallest detail, allowing users to rely on their instruments at all times.

Massive base frame, stable support

The base plate of these pendulum impact testers are made of a vibration-damping cast material and comply with the mass to pendulum mass ratio as specified in the standards. Three massive, lockable leveling-feet ensure firm support and provide the necessary leveling capability.

Pendulum coding as standard

Each individual pendulum is automatically identified by the instrument, eliminating the possibility of confusion.

Ergonomic control layout

The controls are located at optimum operating height.

Tool-free pendulum change

Each pendulum hammer is equipped with a quick-change device to enable pendulum changes with no need for additional tools.

Easy method changeover

The support fixtures for the various methods are stored securely in a dovetail guide.

To change over, a few screws are slackened slightly and the fixture is pushed out. Dependable limit switch stops ensure exactly reproducible positioning.



Fig. 2: HIT5P pendulum impact tester



Fig. 1: The right instrument for every application: pendulum impact testers L to R: HIT5P, HIT5.5P and HIT25/50P. Various hammers are available for each instrument.

Low-vibration pendulums

As well as increasing the stiffness of the pendulum in the impact direction, the use of double pendulum rods made of pultruded CFRP concentrates the mass better at the impact point compared to metal pendulums, minimizing energy losses due to natural vibrations.

Certified maximum test-result reliability

The MPA NRW has certified a pendulum impact tester from this range as suitable for 'definitive tests'. This is the highest acceptance level that a pendulum impact tester can achieve.

Instrumentation

Force and travel sensors plus fast measured-value acquisition are used to determine the force-travel-time gradient. The system records the measured-value curve and the characteristic values, enabling fracture mechanics investigations to be carried out or – a simple tough-brittle transition identified.

Powerful: 4 MHz measured-value acquisition with 16-bit resolution and 200,000-point memory depth.

Tests at low temperatures

For tests at low temperatures, specimens are first temperature-conditioned in a refrigerator box. The magazine plus specimens is then positioned on the specimen dispenser, which is attached to the HIT pendulum impact tester. This allows specimens to be removed and tested quickly and conveniently. A digital thermometer is optionally available for monitoring the temperature in the magazine.

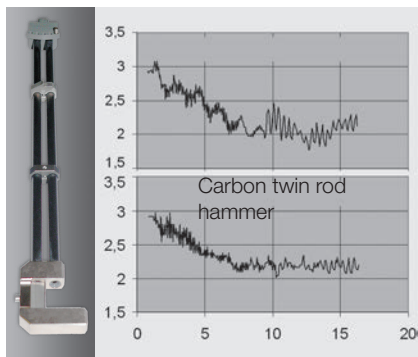

Fig. 1: Stiff carbon twin-rods minimize energy loss

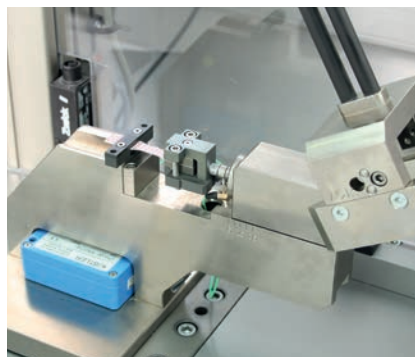

Fig. 3: Tensile-impact instrumentation at the vise

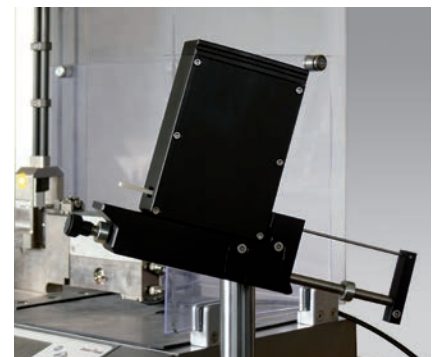

Fig. 4: Specimen dispenser for tests at low temperatures

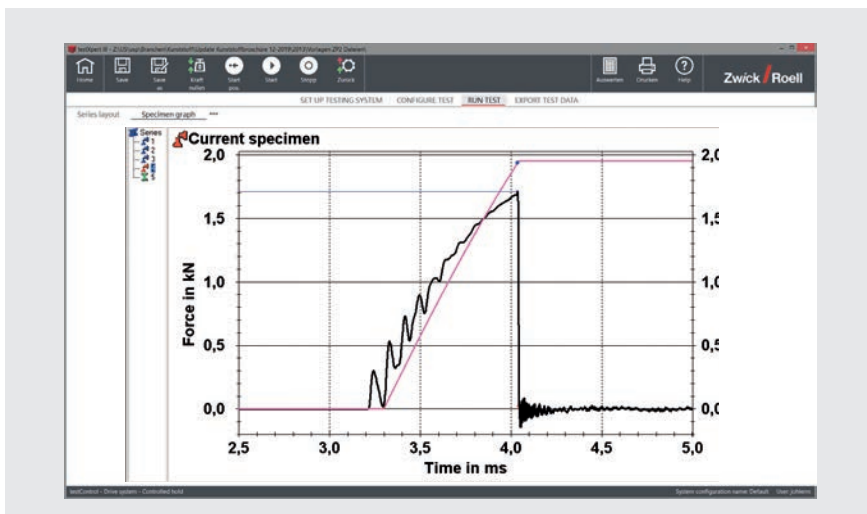

Fig. 2: Instrumented pendulum impact testers allow impact force and travel-time data to be recorded

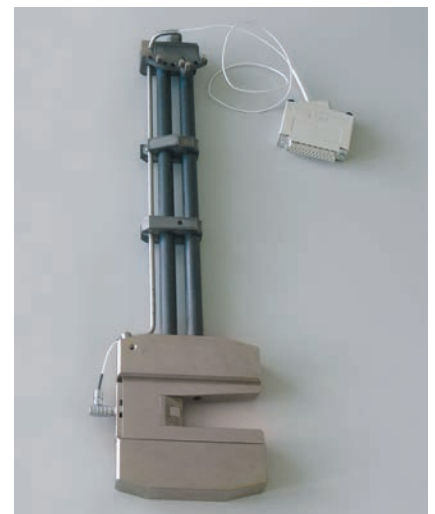

Fig. 5: For Charpy tests the top of the hammer is instrumented



Fig. 1: Charpy test

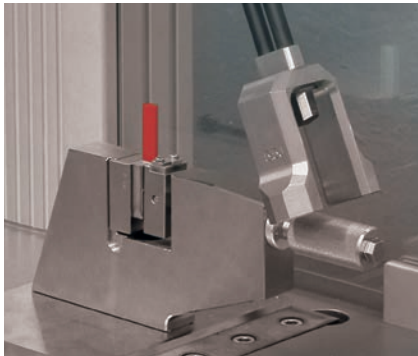

Fig. 2: Izod test



Fig. 3: Tensile-impact test, ISO method A



Fig. 4: Dynstat impact test

		Standard requirements			HIT 5 P		HIT 5.5 P		HIT 25 P		HIT 50 P		
Method	Standard	Pendulum energy		Velocity at impact	Stand Alone	PC	Stand Alone	PC	Stand Alone	PC	Stand Alone	PC	
		J	ft lbf										m/s
Charpy	ISO 179	0.5	0.37	2.9 m/s (±10%)	•	•	•	•	•	•	•	•	
		1	0.74		•	•	•	•	•	•	•	•	
		2	1.48		•	•	•	•	•	•	•	•	
		4	2.95		•	•	•	•	•	•	•	•	
		5	3.69		•	•	•	•	•	•	•	•	
		7.5	5.53		-	-	-	-	-	-	-	-	-
		15	11.1		3.8 m/s	-	-	-	-	-	-	-	-
	25	18.4	(±10%)	-	-	-	-	-	-	-	-	-	
	50	36.9		-	-	-	-	-	-	-	-	-	
	ASTM D 6110	0.5	0.37	approx.	-	-	•	•	•	•	•	•	
		1	0.74	3.46 m/s	-	-	•	•	•	•	•	•	
		2.7	2		-	-	•	•	•	•	•	•	
		5.4	4		-	-	•	•	•	•	•	•	
		10.8	8	(Height of fall:	-	-	•	•	•	•	•	•	
21.6		16	610±2 mm)	-	-	•	•	•	•	•	•		
Izod and "Unnotched cantilever beam impact"	ISO 180	1.0	0.74	3.5 m/s (±10%)	-	-	•	•	•	•	•	•	
		2.75	2.03		-	-	•	•	•	•	•	•	
		5.5	4.06		-	-	•	•	•	•	•	•	
		11	8.11		-	-	•	•	•	•	•	•	
		22	16.2		-	-	•	•	•	•	•	•	
ASTM D 256 / D 4812	1.0	0.74	approx.	-	-	•	•	•	•	•	•		
	2.75	2.03	3.46 m/s	-	-	•	•	•	•	•	•		
	5.5	4.06		-	-	•	•	•	•	•	•		
	11	8.11	(Height of fall:	-	-	•	•	•	•	•	•		
	22	16.2	610±2 mm)	-	-	•	•	•	•	•	•		
Tensile impact	ISO 8256 – method A	2.0	1.48	2.9 m/s	•	•	•	•	•	•	•	•	
		4.0	2.95	(±10%)	•	•	•	•	•	•	•	•	
		7.5	5.53		-	-	-	-	-	-	-	-	
		15.0	11.1	3.8 m/s	-	-	-	-	-	-	-	-	
		25.0	18.4	(±10%)	-	-	-	-	-	-	-	-	
		50.0	36.9		-	-	-	-	-	-	-	-	
Tensile impact – "tensile-in-head" method	ISO 8256 – method B	2.0	1.48	2.9 m/s	-	-	•	•	•	•	•	•	
		4.0	2.95	(±10%)	-	-	•	•	•	•	•	•	
		7.5	5.53		-	-	-	-	-	-	-	-	
	ASTM D 1822	15.0	11.1	3.8 m/s	-	-	-	-	-	-	-	-	
		25.0	18.4	(±10%)	-	-	-	-	-	-	-	-	
		50.0	36.9		-	-	-	-	-	-	-	-	
Dynstat	DIN 53435	0.2	0.15	2.2±0.1 m/s	-	-	-	-	-	-	-	-	
		0.5	0.37		-	-	•	•	•	•	•	•	
		1.0	0.74		-	-	•	•	•	•	•	•	
		2.0	1.48		-	-	•	•	•	•	•	•	
		4.0	2.96		-	-	•	•	•	•	•	•	

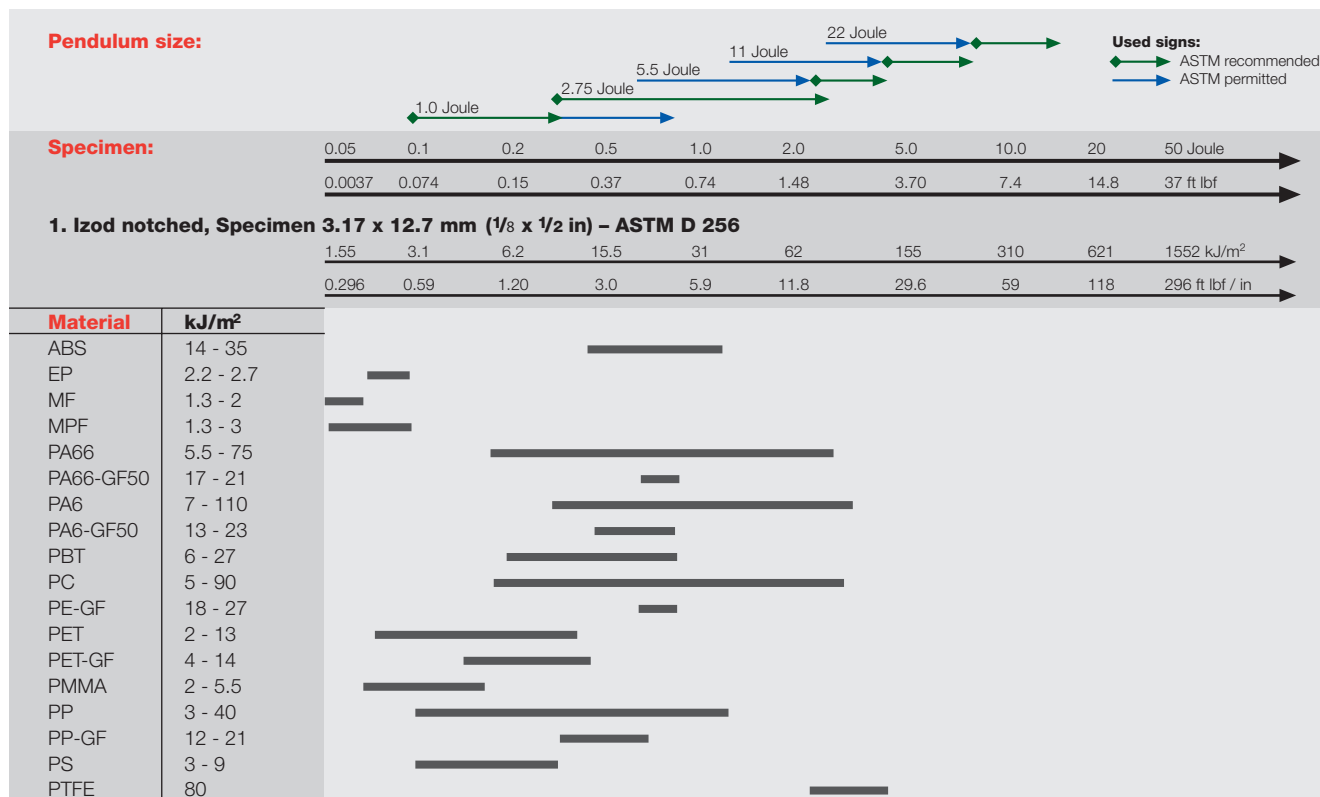

Fig. 1: Indicated values for Izod impact resilience according to ASTM standard are only valid for specimen cross sections of 1/8" x 1/2" (3.17 x 12.7 mm).

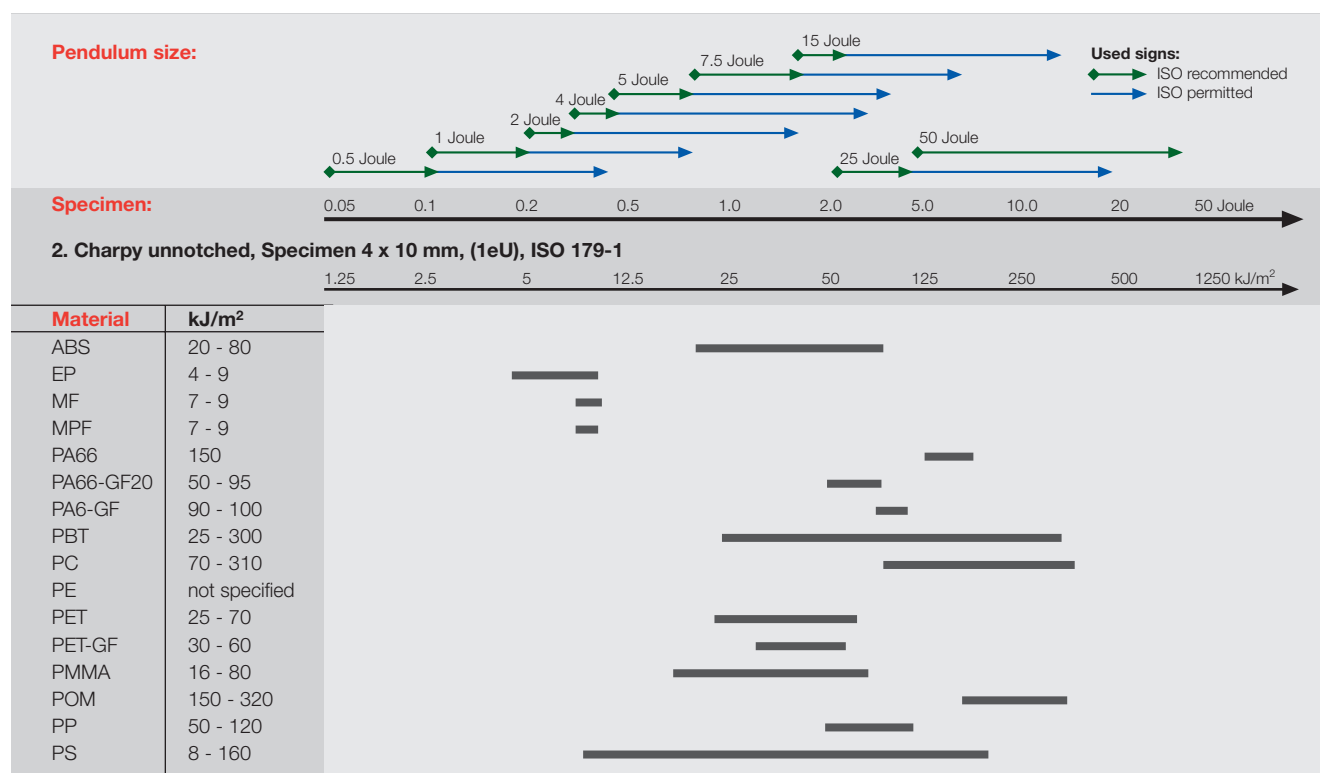

Fig. 2: Indicated values for Charpy impact resilience are only valid for unnotched specimen, 10 x 4 mm.

4.8 Rebound resilience

ZwickRoell has two different instruments for determination of rebound resilience.

ZwickRoell 5109 rebound resilience tester

This instrument, also known as a Schob pendulum, is suitable for rebound resilience investigations on rubber, elastomers and soft foams in accordance with the following standards:

- ISO 4662, DIN 53512, ASTM D 1054, Method B rebound resilience of rubber and elastomers
- DIN 13014, DIN 53573: rebound resilience of flexible foams.

Pendulums as per ISO 4662, DIN 53512 and ASTM D 7121

Energy: 0.5 J
Pendulum mass: 101 g
Striking-edge shape: hemispherical
Diameter: 30 mm
Application: rubber, elastomers

Pendulum as per DIN 13014

Energy: 0.196 J
Pendulum mass: 101 g
Striking-edge shape: hemispherical
Diameter: 30 mm
Application: mattresses

Options

Electrically heated specimen holders (ambient to 100 °C)

4.9 HTM high-speed testing machines

High-speed testing machines are hydraulically driven multiaxial impact or high-speed tensile testing machines and can generate speeds up to 20 m/s.

In addition to multiaxial impact tests, high-speed tensile tests, e.g. to ISO 18872, can be performed at low and high rates.

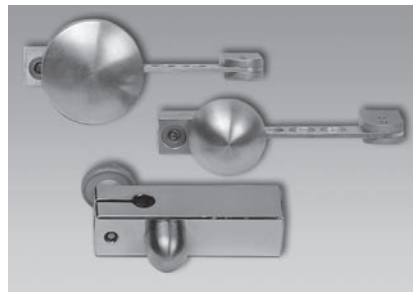

Fig. 2: A selection of pendulum hammers



Fig. 1: ZwickRoell 5109 rebound resilience tester with digital display



Fig. 3: HTM high-speed testing machine

Amsler Drop weight testers

Drop weight testers are used to determine the impact behavior of polymers by various instrumented test methods: Multi-axial impact on platens, sheets or film, Charpy, Izod and tensile impact with standardized specimen and Compression-After-Impact, CAI, for fiber reinforced composites. Finished parts and elements, such as dampers, mats, helmets and other safety protection equipment can be tested under standardized close-to-life conditions. All drop weight testers run with the comfortable testXpert III software offering full visualization, evaluation and data processing of the test curves and results.

Amsler HIT 230F

This model is optimized for multi-axial impact tests to ISO 6603-2 and other standards. It produces a

potential energy of 230 J by a free falling mass of 23.5 kg and an adjustable drop height of up to 1.0 m. The strength of this instrument is its perfect accessibility to the test area, allowing fast and comfortable operation and direct specimen feeding from a cooling box in case of low temperature testing. The instrument can also be equipped for CAI tests with some supplementary accessories.

Amsler HIT600F

This enhanced drop weight tester offers a maximum potential energy of 650 J, a maximum falling mass of 40.4 kg, a drop height of 1.3 m and an optional acceleration unit to boost the max. speed to 8.1 m/s. The instrument covers the needed speed range of 6.6 m/s required by many automotive standards. This model can be equipped for different

test methods. It offers the same ease-of-operation as the smaller model HIT230F.

Amsler HIT1100F and HIT2000F

These models are optimized for testing of parts and elements. The robust design of all guides offers safety, even if side loads are to be expected. Drop masses of up to 30,07 kg, a maximum free falling height of 1,0 m / 1.5 m and an acceleration unit offer a potential energy of up to 1125 J / 2053 J and max impact speed of 14,1 / 18,6 m/s. Accessories for standard material test methods such as multiaxial impact, Charpy, Izod and tensile-impact are available. An in-built temperature chamber allows low-temperature tests.

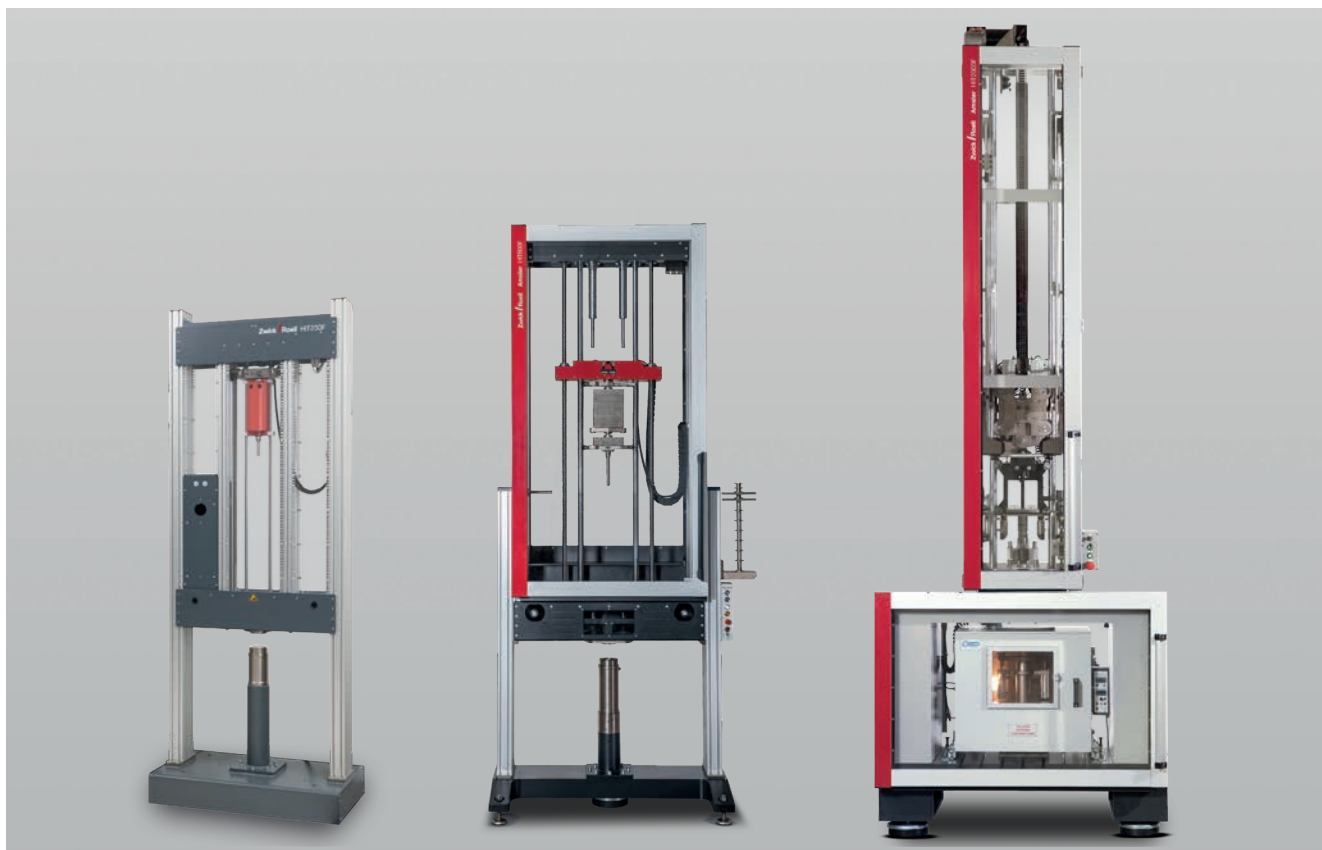

Fig. 1: Drop-weight testers Amsler HIT230F, Amsler HIT600F and Amsler HIT2000F

4.10 Extrusion plastometers

Extrusion plastometers provide standard values for the melt mass flow-rate (MFR) and melt volume flow-rate (MVR) of thermoplastics under specified conditions.

The tests are described in ISO 1133-1 and ASTM D 1238, while ASTM D 3364 defines a method for testing PVC.

ISO 1133-2 defines a method for moisture and time-dependent polymers such as PA, PET and PBT. This method places increased demands on instrument, conditioning and test performance.

Exact temperature control

All ZwickRoell extrusion plastometers operate with a temperature display resolution of 0.1 °C or better. As well as complying with standardized limits, the control system also satisfies the demanding temperature constancy requirement of better

than 0.3°C with travel and time, as specified in ISO 1133 Part 2.

Adaptive Parameter Configuration (APC)

Different test parameters produce optimum test-result accuracies, depending on the flow rate to be measured. The APC function determines the optimum parameters from the piston velocity shortly before the start of the test, ensuring maximum possible result reliability.

Cflow compact extrusion plastometer

Cflow is a cost-effective compact instrument for rapid monitoring of the melt mass flow rate of plastics.

It is primarily designed for plastics processors who do not require a connection to a PC.

Temperature control of the heating elements, heating chamber and barrel are all perfectly co-ordinated.

Optionally available for Cflow are an automatic or manual extrudate cutter, a safety door and a die plug.

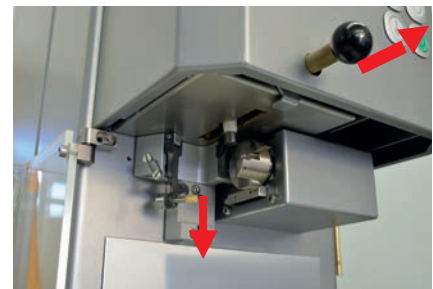

Fig. 2: Die release slide



Fig. 3: Extrudate cutter and die-plug



Fig. 1: Xflow range of extrusion plastometers: accurate temperature control plus preparation for tests on PA, PBT and PET (top right). Adaptive Parameter Configuration (APC): every test is performed with optimum test parameters right from the start (bottom right).



Fig. 1: The modular Mflow. Left with weight-lifting unit, right with weight pre-selector

Mflow - modular extrusion plastometer

The basic version of this instrument can be used to determine the MFR value to Method A.

Use of the displacement transducer expands the instrument for MVR measurements as per Method B and for Automatic Parameter Control (APC).

Advantages:

- high temperature accuracy
- automatic parameter control (APC)
- modular design – retrofit capability
- stand-alone operation or
- convenient PC control via testXpert III
- automatic bubble detection
- wide range of accessories.

Aflow - the allround extrusion plastometer

Aflow impresses with its high level of automation. From simple cleaning and defined pre-compacting at the touch of a button, to stepless test load adjustment – Aflow is ready for your testing situations.

Pre-compacting delivers relatively low scatter, even with frequent operator changes. The post-test sequence can be accelerated by ejecting the residual material from the extrusion barrel with a force of up to 80 kg, followed by pneumatic cleaning at the touch of a button.

The instrument also allows precise measurement up to very high MFR values in a load range up to 50 kg.

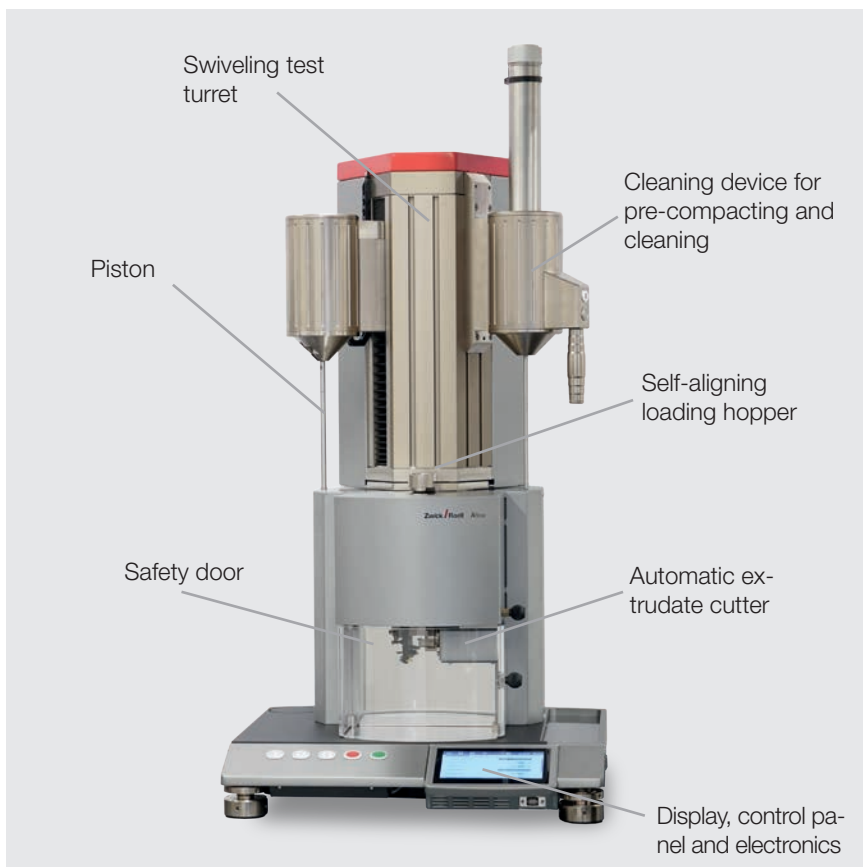

Fig. 2: The Aflow extrusion plastometer features robust construction and a high level of automation for heavy-duty operation with a minimum of operator influence

4.11 HDT and Vicat

HDT/Vicat Standard

HDT/Vicat Standard instruments are designed for use in incoming goods inspections and product monitoring, as well as for education and training purposes. Different versions of the instruments are available, with up to 6 measuring stations according to requirements. Connection to a PC allows convenient test-sequence parameterization and test curve display.

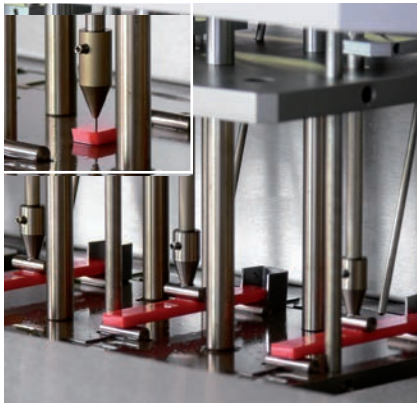

Fig. 1: Vicat softening temperature (top); heat distortion temperature (bottom)

Functions, elements and interfaces

- test temperatures up to 300 °C
- built-in temperature control and data acquisition
- clearly visible measured-value display
- safety thermostat
- electronic fluid level-monitoring
- sequence control and data acquisition via PC with testXpert III
- integrated compensation for heat expansion of measuring stations (with PC operation)
- manual lowering of measuring stations
- manual application of weights
- manual or solenoid-valve-controlled cooling via copper coil.

PC-controlled test sequence

As soon as the heat-transfer fluid has reached starting temperature the specimens are placed in the measuring stations, which are then lowered manually into the bath. The test weight is then applied manually and the menu-controlled test sequence started on the PC.

Following completion of pre-tempering under force, the travel signals are set to zero (program-controlled) and heating of the heat-transfer fluid at the previously set rate is started.

As soon as the test is completed the heating is switched off. Re-cooling of the heat-transfer liquid is started by the PC via a solenoid valve.



Fig. 2: HDT/Vicat 3-300 S basic instrument: measurements up to 300 °C, 1 to 3 stations



Fig. 3: The HDT/Vicat 6-300 S has a solenoid valve to regulate cooling and can be equipped with 1 to 6 measuring stations.

HDT/Vicat Allround

The instruments in the Allround range are equipped throughout with a motorized hoist for lowering the measuring stations into the oil bath at the start of the test and raising them after the test.

In addition all instruments are fitted with automatically controlled re-cooling; depending on the type of instrument this is in the form of either a coil or an more efficient heat exchanger unit.

Vicat Dry

ISO 306 (Vicat test) describes the 'dry method' as performed via this instrument. It has been demonstrated in comparative tests that results are statistically identical with results obtained using an oil bath.

No more irritating oil fumes!

Vicat Dry instruments represent a very pleasant and convenient testing solution. The oil-free measuring principle ensures clean, odor-free working conditions, while the test sequence is completely automatic. Parameterization of the test sequence and data and curve display is conveniently performed on the PC.



Fig. 3: The Vicat Dry's oil-free measuring principle ensures clean working conditions



Fig. 1: The HDT/Vicat 3-300 A and 6-300A with integrated heat exchanger and three or six measuring stations.



Fig. 2: Allrounders HDT/Vicat 3-300A and 6-300A are fitted with a hoist, enabling the entire test to run automatically. They are equipped with a bath to accommodate three or six measuring stations.

4.12 Robotic testing systems

Automatic specimen feeding or handling systems are used extensively in research and development where there is a requirement for statistically dependable material characteristic values. Specimen feeding systems are available in various task-specific versions.

Advantages of automated testing:

- objective - operator-independent test results
- greater result reproducibility
- expanded testing capacity - no operator required for tests during night shift or at weekends.

'roboTest A' and 'roboTest B'

With its compact design, this robotic system allows fully automatic testing of small test lots. The testing machine can still be operated manually. 'roboTest' A is designed for tensile tests at ambient temperature, while robotest B can be equipped to feed specimens for flexure tests as well. Both systems possess a magazine with 20 slots.

'roboTest F'

The 'roboTest F' robotic system is primarily used for testing films and fabrics at room temperature and consists of a movable stand plus a rotating chain with spring clips. Up to 200 specimens can be held in the magazine system.



Fig. 1: Automated feeding of up to 20 rigid tensile specimens 'roboTest A'.



Fig. 3: 'roboTest F' for automatic feeding of film and fabric specimen.

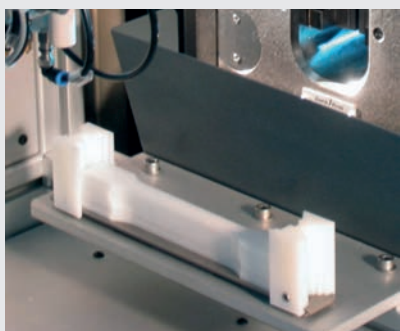
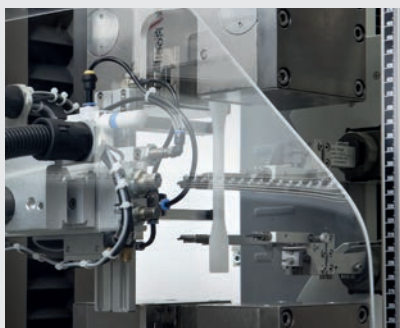

Fig. 2: 'roboTest B' - easy changeover between tensile and flexural testing. Automatic specimen feed from magazines holding up to 20 specimens

'roboTest L'

This system uses pneumatic suction grippers or claw grippers. Up to 450 tensile or flexure specimens or up to 300 ring-type specimens can be stored in the magazines



Fig. 1: 'roboTest L' - tensile and flexure tests on plastics and rubber. The large specimen magazine allows operation overnight and at weekends.

'roboTest R'

In this system an industrial robot provides specimen feed to multiple testing machines and instruments, a cross-section measuring-station or scales. This system is also used to feed specimens into a temperature chamber.



Fig. 2: 'roboTest R' - specimen feeding system incorporates multiple testing equipment, e.g. for tensile and flexure tests, impact and hardness tests. Large specimen magazine and tests in temperature chambers are functions of this system.

'roboTest H'

Up to 20 specimens are transported quickly and reliably from a pre-cooled magazine. Less than 3 seconds elapse between removal from the magazine and impact. Magazines can be changed very quickly.



Fig. 3: Specimen feeding for Charpy and Izod - 'roboTest H'

4.13 Hardness testers

ZwickRoell supplies hardness testers for all established polymer test methods.

Shore A hardness and the various IRHD methods are used for rubber and elastomers, while Shore D, ball-indentation hardness and Rockwell methods are suitable for measurements on semirigid and rigid plastics.



Fig. 1: Shore A and D calibration stand

Hard, glass-fiber-reinforced plastics and composites can be tested using the Barcol method. In addition there are special test methods, e.g. for asphalt, thin foam components or floor coverings.



Fig. 2: Analog Shore hardness tester



Fig. 4: Digital Shore hardness tester with integral electronics unit



Fig. 3: Analog Shore A hardness tester with test stand



Fig. 5: Digital Shore hardness tester with test stand

Shore A , D, B, C, 0 and 00

Analog hardness testers for various Shore scales are available in versions with and without drag indicator for display of maximum values.

Digital versions possess a spring-loaded outer ring which ensures correct contact force while preventing twisting. The electronic measuring unit controls the measurement time and allows convenient data transfer to a PC, either directly or by uploading from the instrument's internal memory.

Test stands

For precise laboratory measurements it is advisable to use a test stand.

Verification devices

Certified measuring rings with a thickness manufactured exactly to a defined Shore value are used to verify the operation of the indenter, while a calibration stand is available to check the measuring springs of the Shore instrument. A weight is pushed via a lever arm to a position corresponding to a Shore value.

ZwickRoell 3103 IRHD micro compact

This electronic instrument with digital display is used for accurate measurement of IRHD micro hardness.

ZwickRoell 3105 combi test

With this instrument the entire measurement cycle runs automatically. Easily interchangeable measurement heads are available for all IRHD and Shore methods.

- Shore A, B, 0
- Shore D, C, D0
- Micro-Shore
- IRHD M, N, H, L
- IRHD supersoft (VLRH)



Fig. 1: ZwickRoell 3103 IRHD micro compact



Fig. 2: Hardness test on O-rings

A centering device ensures reliable measurements on O-rings.

ZHR8150CLK hardness tester

ZHR8150CLK hardness tester offers reliable test results for more than 30 different applications of depth measurement methods, for example, Rockwell and ball indentation to HR (Alpha), ISO 2039-1 and 2039-2, ASTM D785 (A & B).

- Automatic test sequence and automatic conversion in alternative hardness scales save time and guarantee a high level of repeatability.
- Its robust design with play-free, ball bearing lead screw and ease



Fig. 3: ZwickRoell 3105 combi test

of operation provides optimal operation for use in production.



Fig. 4: ZHR8150CLK hardness tester

4.14 testXpert® III – the new software generation for materials testing

With testXpert ZwickRoell introduced a uniform operating concept for all applications – regardless of whether testing machines, automation, pendulum impact testers, extrusion plastometers, hardness testers or drop-weight testers are involved.

What advantage does this offer? Learning how to handle the software is less time-consuming. testXpert III users benefit from over 150 years' materials testing experience and more than 35,000 successful installations around the world.

Simply ingenious

testXpert III's stand-out feature is its amazingly simple, intuitive operation. Meaningful icons and a clear menu structure enable rapid orientation and significantly reduce the familiarization phase.

Ready-made Standard Test Programs

Pre-programmed and tested Standard Test Programs are available for all established standardized tests. This simplifies the first steps and ensures that the test sequence and results evaluation will be in compliance with the standard.

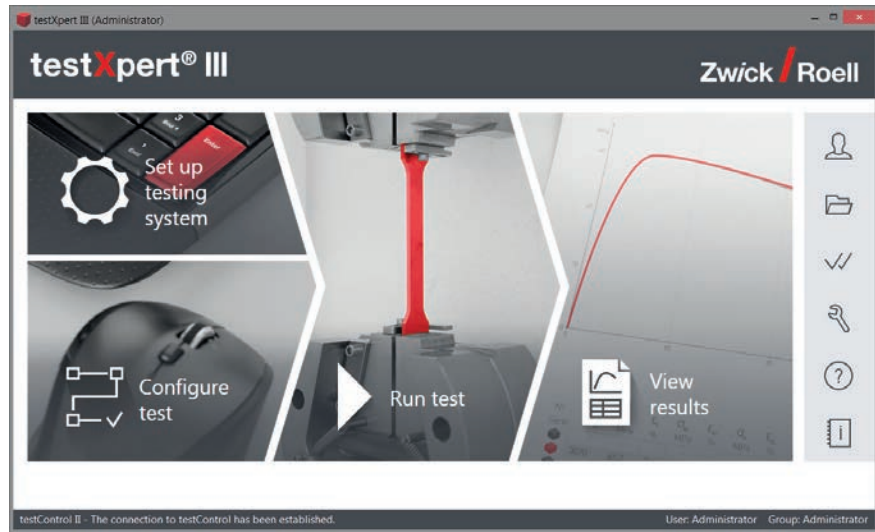

Fig. 1: With over 35,000 installations worldwide, testXpert is one of the most successful materials testing software on the market

Flexible Master Test Programs

Greater freedom in designing the test sequence, operating steps, result calculation and data logging is offered by Master Test Programs, which enable each parameter to be set individually.

Testing

The individual data are displayed – online to the test procedure – on the monitor screen. The test can be followed live and if required an exactly synchronized video recording can be included.

Results are calculated during the test, so the test sequence can be event-controlled; for example with a change of speed following determination of the tensile or compression modulus.

Evaluating test results

As many different screen layouts as required can be compiled in testXpert III, for example with additional graphics, different displays of test curves, tables and additional statistics.



4.15 Load cells

Load cells must satisfy the most demanding quality requirements. The basis for this is calibration to ISO 7500-1 or ASTM E4. This is in the form of a factory calibration and can be repeated following commissioning of the test equipment by our Service Department as a DAkkS, COFRAC or NAMAS calibration. This means that you can always rely on your testing machine.

But there is much more to Xforce load cells - available exclusively from ZwickRoell - than that.

Parasitic influences such as temperature and transverse forces have significantly less impact on test results than with other comparable load cells. Xforce load cells are also very robust and more resistant to factors such as transverse forces during compression and flexure tests.

Temperature compensation makes measuring largely independent of the actual ambient temperature.



Fig. 2: Every load cell undergoes a ZwickRoell factory calibration as soon as it enters service on a testing machine

This all takes place in a very large measurement range, within Accuracy Class 0.5 or 1. Load cells in the Xforce HP/K range typically achieve

a display deviation better than $\pm 1\%$ from as low as 0.1% of their nominal load.



Fig. 1: Load cells for the most demanding quality requirements. Left: a load cell from the Xforce range. Center: Xforce HP design uses the ring-torsion measurement principle.

4.16 Specimen grips

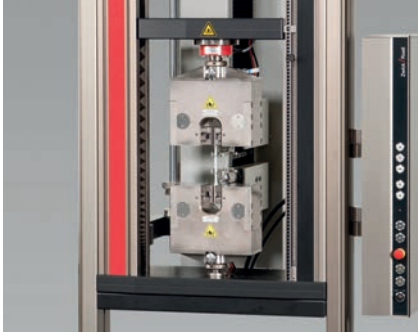

Fig. 1: Pneumatic and mechanical grips for various applications

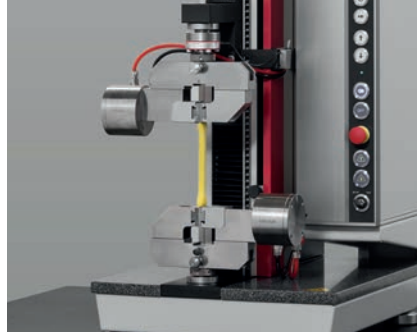

Fig. 2: Screw-type grips

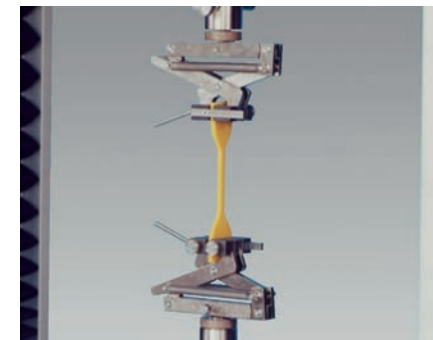
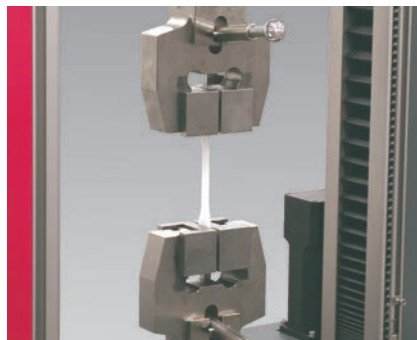

Fig. 3: Mechanical grips with load-dependent clamping for reliable clamping of soft and brittle materials



Fig. 4: Grips for specific materials and specimen shapes: ring testing device, toggle grips



Fig. 5: Spring loaded grip



Fig. 6: The Modular BoW gripping system allows easy change of configuration



4.17 Extensometers

ZwickRoell has the most wide and varied range of extensometers for polymer testing.

makroXtens, multiXtens

Automatic mechanical extensometers makroXtens II and multiXtens satisfy the exacting requirements of ISO 527-1 for modulus determination. Changing the sensor arms enables various types of tests, together with measurement at ambient and in temperature chambers. Tilting knife-edges prevent transmission of excessive forces and ensure safe, reliable operation, even with brittle specimen fractures.

videoXtens

videoXtens uses image processing, allowing longitudinal and transverse strain to be determined with great accuracy.

lightXtens for long extensions

Mechanical long-travel extensometers are employed when no tensile modulus is required. The optical variant lightXtens is especially suitable for specimens prone to whipping and for measurements in temperature chambers.

Manual clip-on extensometer

Digital and analog clip-on extensometers are available in many different versions.

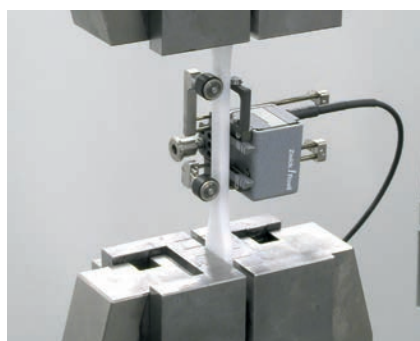

Fig. 1: digiClip - digital clip-on extensometer

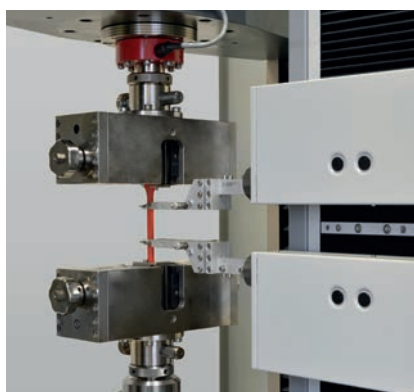

Fig. 2: makroXtens II (left above) and multiXtens (left below) for tensile, compression and flexure tests

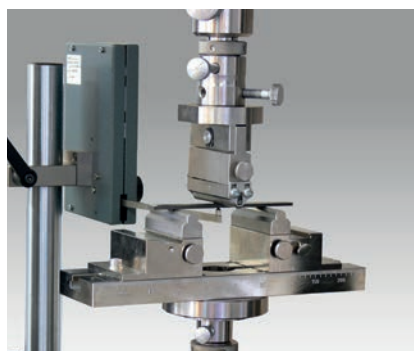

Fig. 3: Flexure transducer for 3 and 4-point measurement



Fig. 4: Mechanical long-travel extensometer

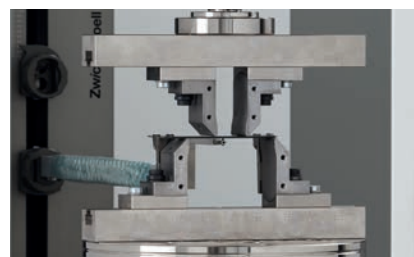
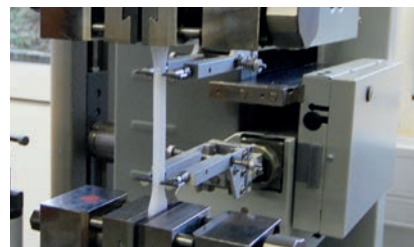

Fig. 5: videoXtens HP for optical measurement of longitudinal and transverse strain



Fig. 6: lightXtens - optical long-travel extensometer

4.18 RetroLine modernization packages for all makes of materials testing machines

ZwickRoell has transformed several thousand materials testing machines from over forty different manufacturers into state-of-the-art equipment in respect of measurement and control electronics, drive technology and testing software. The measurement and control electronics, drive technology and testing software used in the modernization process have been proven and standardized in new machines. For reliable, expert modernization of your testing machine - talk to ZwickRoell.

Modernization based on innovative ZwickRoell components means:

- reliable service and support for the entire system for a minimum of 10 years
- full compatibility with a comparable new machine
- re-use of virtually all existing accessories
- accessories from ZwickRoell's comprehensive range can be installed
- future-proof – later developments can be installed
- compliance with all safety-relevant legal requirements.

If required, the modernization, including full overhaul and painting, will be carried out at ZwickRoell's premises in Ulm.

With the necessary safety devices in place the testing machine will then receive the CE mark and corresponding manufacturer's declaration confirming compliance with European safety requirements.



Fig. 1: At ZwickRoell we modernize both our own testing machines and those of many other manufacturers (right)

4.19 Service from start to finish. You can depend on ZwickRoell!

Your testing system is in good hands with ZwickRoell. Our technical advisors and experienced applications engineers are ready with expert advice and our Applications Test Laboratories are equipped with numerous static and dynamic materials testing systems.

ZwickRoell service technicians guarantee successful, trouble-free commissioning – from pre-acceptance and installation, to initial calibration, to instruction on hardware and software, including full safety briefing. Our service technicians will also carry out the required annual inspection and calibration.

Our Hotline staff will assist you in questions relating to hardware and software malfunctions, while the Support Desk guarantees individual advice or rapid assistance via remote access. Repairs will be effec-



Fig. 2: ZwickRoell technicians guarantee first-class service in over 50 countries

ted directly on-site or at ZwickRoell's premises; this includes 24-hour spare-part dispatch and individual spare-part packages.

Training courses provided by the ZwickRoell Academy cover all aspects of materials testing, both in Ulm or at a location near you.

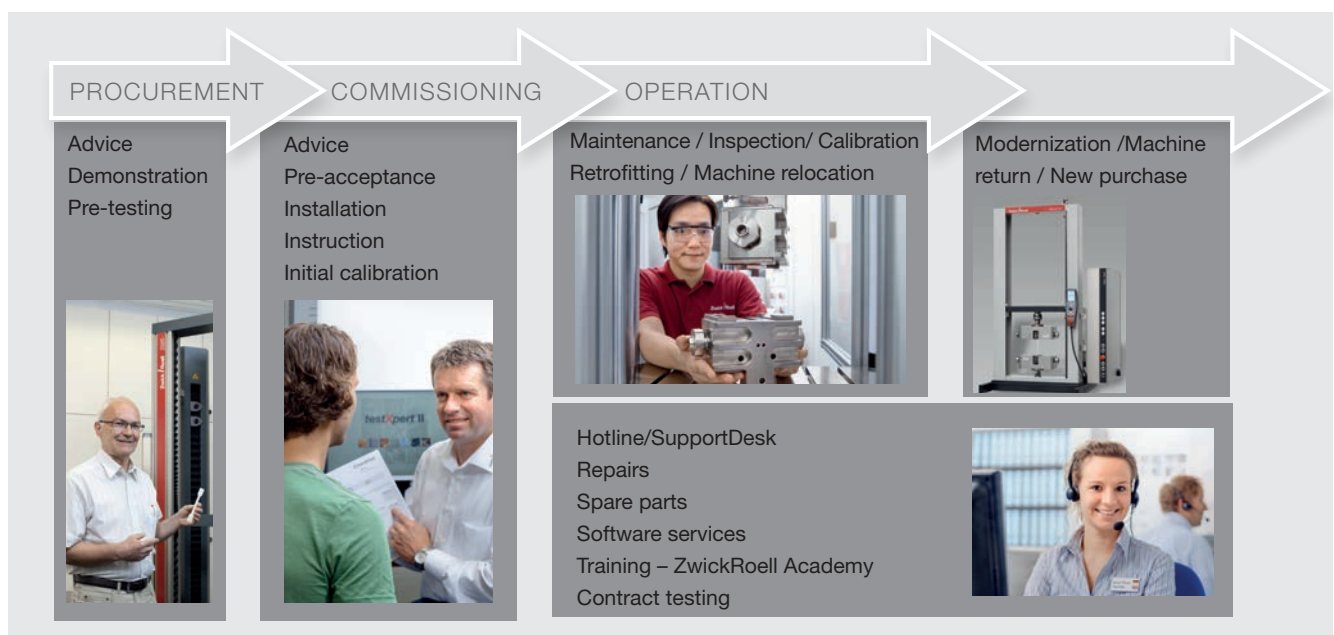
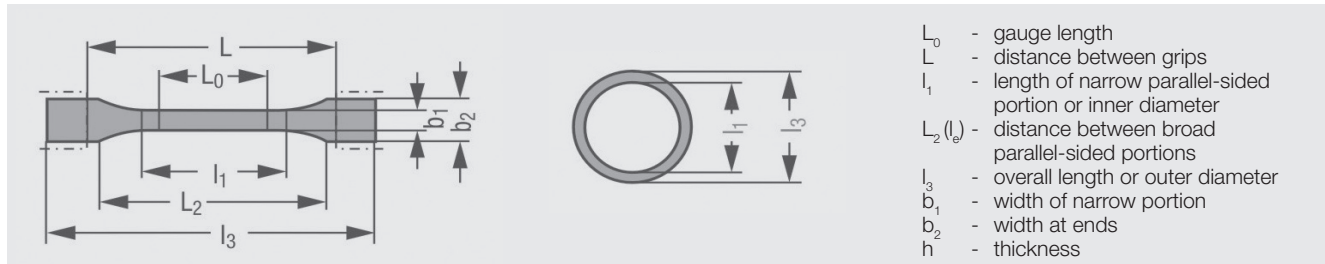

Fig. 1: ZwickRoell provides continuous support throughout the life-cycle of materials testing systems.

5 Specimen shapes and standards overview

5.1 Specimen shapes, specimen dimensions and cutting dies

Note: The item numbers in the following tables have to be prefixed by H06.710



- L_0 - gauge length
- L - distance between grips
- l_1 - length of narrow parallel-sided portion or inner diameter
- $L_2 (l_2)$ - distance between broad parallel-sided portions
- l_3 - overall length or outer diameter
- b_1 - width of narrow portion
- b_2 - width at ends
- h - thickness



Thermoplastic and thermosetting materials



Standard	Type Application	l_3 mm	l_1 mm	b_2 mm	b_1 mm	h mm	L_0 mm	L mm	Shape	Cutting die/ spare die ¹⁾
ISO 20753	A1 Multi purpose specimen (Injection moulding)	≥ 170	80 ± 2	20 ± 0.2	10 ± 0.2	$4,0 \pm 0.2$ (preferred)	-	115 ± 1		-
ISO 20753	A2 Multi purpose specimen (Machining)	≥ 150	60 ± 0.5	20 ± 0.2	10 ± 0.2	$4,0 \pm 0.2$ (preferred)	-	115 ± 1		B.019 / 020
ISO 20753	A12 Specimen proportional 1:2 to A22 A1 respectively A2	≥ 75	30 ± 0.5	10 ± 0.5	5 ± 0.5	$2,0 \pm 0.1$	-	-		-
ISO 20753	A13 Specimen proportional appr. A23 1:3 to A1 respectively A2	≥ 60	24 ± 0.5	$7,2 \pm 0.2$	$3,5 \pm 0.2$	$1 \text{ or } 2 \pm 0.05$	-	-		B.201 / 202
ISO 20753	A14 Specimen proportional 1:4 to A24 A1 respectively A2	≥ 45	20 ± 0.5	$5,0 \pm 0.2$	$2,5 \pm 0.1$	$1,0 \pm 0.1$	-	-		-
ISO 20753	A15 Specimen proportional 1:5 to A25 A1 respectively A2	≥ 30	12 ± 0.5	4 ± 0.2	$2,0 \pm 0.1$	$2,0 \pm 0.1$	-	-		B.153 / 154
ISO 20753	A18 Specimen proportional 1:8 to A28 A1 respectively A2	≥ 23.8	10 ± 0.5	$2,5 \pm 0.1$	$1,25 \pm 0.05$	$0,5 \pm 0.1$	-	-		-
ISO 527-2	1A Injection moulded specimen (preferred shape)	170	80 ± 2	20 ± 0.2	10 ± 0.2	$4,0 \pm 0,2$ (preferred)	$75 \pm 0,5$ or $50 \pm 0,5$	115 ± 1		B.089 / 090 ²⁾
ISO 527-2	1B Compression moulded or machined specimen (preferred shape)	≥ 150	60 ± 0.5	20 ± 0.2	10 ± 0.2	$4,0 \pm 0,2$ (preferred)	$50 \pm 0,5$	115 ± 1		B.019 / 020
ISO 527-2	1BA Specimen proportional 1:2 to type 1B	≥ 75	30 ± 0.5	10 ± 0.5	5 ± 0.5	≥ 2	25 ± 0.5	$l_2^{3)+2^{3)}$ $l_2 = 58 \pm 2$		B.201 / 202
ISO 527-2	1BB Specimen proportional 1:5 to type 1B	≥ 30	12 ± 0.5	4 ± 0.2	2 ± 0.2	≥ 2	10 ± 0.2	$l_2 + 5^{3)}$ $l_2 = 23 \pm 2$		B.153 / 154
ISO 527-2	5A Specimen identical to ISO 37 type 2 similar to ISO 527-3 type 5	≥ 75	25 ± 1	12.5 ± 1	4 ± 0.1	≥ 2	20 ± 0.5	50 ± 2		B.005 / 006
ISO 527-2	5B Specimen identical to ISO 37 type 4 similar to ISO 527-3 type 5	≥ 35	12 ± 0.5	6 ± 0.5	2 ± 0.1	≥ 1	10 ± 0.2	20 ± 2		B.083 / 084
ASTM D 638 I	Preferred specimen for rigid plastics	≥ 165	57 ± 0.5	19 ± 6.4	13 ± 0.5	$3,2 \pm 0.4$	50 ± 0.25	115 ± 5		B.155 / 156
ASTM D 638 II	Preferred if type 1 does not break in the narrow section	≥ 183	57 ± 0.5	19 ± 6.4	6 ± 0.5	$3,2 \pm 0.4$	50 ± 0.25	135 ± 5		B.157 / 158
ASTM D 638 III	for thickness > 7 mm (rigid and non-rigid plastics)	≥ 246	57 ± 0.5	29 ± 6.4	19 ± 0.5	$7 \dots 14$	50 ± 0.25	115 ± 5		B.057 / 058
ASTM D 638 V	Smaller specimen taken from parts or semi-products	$\geq 63,5$	9.53	$9,53 \pm 3.1$	$3,18 \pm 0.5$	$3,2 \pm 0.4$	7.62	$25,4 \pm 5$		B.161 / 162
ASTM D 638 IV	For comparison between rigid and non-rigid plastics (similar to ISO 37 type 1)	≥ 115	33 ± 0.5	19 ± 6.4	6 ± 0.05	$3,2 \pm 0.4$	25 ± 0.13	65 ± 5		B.159 / 160

¹⁾ Cutting is only possible for specimen showing a hardness less than 85 Shore A. Harder materials shall be machined by use of milling machines or other convenient machinery acc. to ISO 2818.





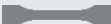
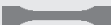
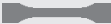
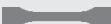













²⁾ This specimen shape is specially designed for moulding. Cut specimens do not correspond to any standard.

³⁾ Value indicates the upper and lower tolerances.

Standard	Type Application	l_3 mm	l_1 mm	b_2 mm	b_1 mm	h mm	L_0 mm	L mm	Shape	Cutting die/ spare die ¹⁾
ISO 178	Flexural properties (center part of multipurpose specimen)	≥80	-	-	10±0.2	4 (preferred)	-	-		machined
DIN 53435	Dynstat flexural test	15±1	-	-	10±0.2	1.2...4.5	-	-		machined

Standard	Type Application	l_3 inch	l_1 inch	b_2 inch	b_1 inch	h inch	L_0 inch	L inch	Shape	Cutting die/ spare die ¹⁾
ASTM D 638 I	Preferred specimen for rigid plastics	≥6.5	2.25	≥0.75	0.5	0.13±0.02	2	4.5		B.167 / 168
ASTM D 638 II	Preferred if type 1 does not break in the narrow section	≥7.2	2.25	≥0.75	0.25	0.13±0.02	2	5.3		B.061 / 062
ASTM D 638 III	For specimen thickness >7 mm (rigid and non-rigid plastics)	≥9.7	2.25	≥1.13	0.75	0.28/0.55	2	4.5		B.057 / 058
ASTM D 638 V	Smaller specimen taken from parts or semi-products	≥2.5	0.375	≥0.375	0.125	0.32±0.02	0.3	1		B.161 / 162
ASTM D 638 IV	For comparison between rigid and non-rigid plastics (similar to ISO 37, type 1)	≥4.5	1.3	≥0.75	0.25	0.32±0.02	1	2.5		B.163 / 164

Rubber and elastomers

Norm	Typ	Bemerkung mm	l_3 mm	l_1 mm	b_2 mm	b_1 mm	h mm	L_0 mm	L	Form Ersatz ¹⁾	Messer/ Messer
ISO 37	1	Preferred size	≥115	33±2	25±1	6+0.4	2±0.2	25±0.5	-		B.009 / 010
ISO 37	1A	Smaller size	100	20±2	25±1	5±0.1	2±0.2	20±0.5	-		B.187 / 188
ISO 37	2	Smaller preferred size	≥75	25±1	12,5±1	4±0.1	2±0.2	20±0.5	-		B.005 / 006
ISO 37	3	Smaller size	≥50	16±1	8,5±0.5	4±0.1	2±0.2	10±0.5	-		B.121 / 122
ISO 37	4	Very small size	≥35	12±0.5	6±0.5	2±0.1	1±0.1	10±0.5	-		B.083 / 084
DIN 53504	S1	Larger size	115	33±2	25±1	6+0.4	2±0.2	25	-		B.009 / 010
DIN 53504	S1A	Smaller size	100	20±2	25±1	5±0.1	2±0.2	20±0.5	-		B.187 / 188
DIN 53504	S2	Preferred size	75	25±1	12,5±1	4±0.1	2±0.2	20	-		B.005 / 006
DIN 53504	S3a	Smaller size	50	16	8,5	4	2±0.2	10	-		B.121 / 122
DIN 53504	S3	Very small size	35	12±0.5	6±0.5	2±0.05	1±0.1	10	-		B.083 / 084
ASTM D 412 C	Preferred size	≥115	33	25±1	6+0.05	1.3...3.3	25±0.25	-	-		B.009 / 010
ASTM D 412 A	Possible size	≥140	59±2	25±1	12+0.05	1.3...3.3	50±0.5	-	-		B.145 / 146
ASTM D 412 B	Possible size	≥40	59±2	25±1	6+0.05	1.3...3.3	50±0.5	-	-		B.143 / 144
ASTM D 412 D	Possible size	≥100	33±2	16±1	3+0.05	1.3...3.3	25±0.25	-	-		B.123 / 124
ASTM D 412 E	Possible size	≥125	59±2	16±1	3+0.05	1.3...3.3	50±0.5	-	-		B.147 / 148
ASTM D 412 F	Possible size	≥125	59±2	16±1	6+0.05	1.3...3.3	50±0.5	-	-		B.149 / 150
ISO 37	A	Normal size	52,6	44.6±0.2			4±0.2	152.7	-		C.003 / 004 + C.099 / 100
ISO 37	B	Small size	10	8±0.1			1±0.1	28.26	-		C.065 / 066 + C.119 / 120

Rubber and elastomers

Standard	Type	Application	l_3 mm	l_1 mm	b_2 mm	b_1 mm	h mm	L_0 mm	L mm	Shape	Cutting die/ spare die ¹⁾
DIN 53504	R1	Preferred size	52.6	44.6			4±0.2	152.7	-		C.003 / 004 + C.099 / 100
DIN 53504	R2	Small size	44.6	36.6			4±0.2	127.5	-		C.005 / 006 + C.007 / 008
ASTM D 412	1	Preferred size	17.9	15.9			1...3.3	50	-		C.121 / 122 + C.123 / 124
ASTM D 412	2	Larger size	35.8	31.8			1...3.3	100	-		C.125 / 126 + C.127 / 128
ISO 34-1	A	Tear test, trouser Preferred size	≥100	-	15±1	-	2±0.2	-	-		D.007 / 008
ISO 34-1	B	Tear test, angle	≥100	-	19±0.05	12.7±0.05	2±0.2	-	-		D.001 / 002
ASTM D 624	C	without nick									
ISO 34-1	C	Tear test, crescend	≥110	-	25±0.5	10.5±0.05	2±0.2	-	-		D.029 / 030
ASTM D 624	B	without nick									
ASTM D 624		Cutting die A	42	-	-	10.2	-	-	-		D.033 / 034





Flexible cellular polymeric materials (soft foams)

Standard	Type	Application	l_3 mm	l_1 mm	b_2 mm	b_1 mm	h mm	L_0 mm	L mm	Shape	Cutting die/ spare die ¹⁾
ISO 1798		Tensile specimen	152	55	25	13	10...15	25/50	-		B.015 / 016
ASTM D 3574 - E		Tensile specimen	139.7	34.9	25.4	6,4	12.5±1.5	20/25			B.039 / 040
ISO 8067		Tear strength, method A	125±25		25±1		25±1				D.093 / 094
		Tear strength, method B	≥100	19	12,7		-				D.001 / 002
ASTM D 3574 - F		Tear resistance test	152.4		25.4		25.4				D.081 / 082



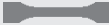







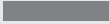

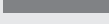
Thin sheetings and films

Norm	Typ	Bemerkung	l_3 mm	l_1 mm	b_2 mm	b_1 mm	h mm	L_0 mm	L	Form	Cutting die/ spare die ¹⁾
ISO 527-3	2	Recommended shape	≤50			10	≤1	50±0.5	100±5		A.149 / 150
		Strip taken with any	≤150			12	≤1	50±0.5	100±5		A.121 / 122
		kind of cutting device	≤150			13	≤1	50±0.5	100±5		A.123 / 124
		L_0 may be reduced	≤150			15	≤1	50±0.5	100±5		A.125 / 126
		to 50 mm for high	≤150			20	≤1	50±0.5	100±5		A.079 / 080
		elongations	≤150			25	≤1	50±0.5	100±5		A.127 / 128
ISO 527-3	5	Specimen shape for quality and control purpose	≥115	33±2	25±1	6±0,4	≤1	25±0.25	80±5		B.009 / 010 or B.125 / 126 (130 mm lg)
ISO 527-3	1B	Specimen shape for quality and control purpose	≥150	60±0.5	20±0,5	10±0.2	≤1	50±0.5	115±5		B.019 / 020
ISO 527-3	4	Specimen shape for thin sheets	≥152	50±0.5	38	25,4±0.1	≤1	50±0.5	73.4		B.085 / 086
ASTM D 882		Strip for quality control	≥150			5...25.4	≤1	100	100		on request
		Strip für modulus measuring	≥300			5...25.4	≤1	250	250		on request

Plastic piping

Standard	Type	Application	l_3 mm	l_1 mm	b_2 mm	b_1 mm	h mm	L_0 mm	L mm	Shape	Cutting die/ spare die ¹⁾
PVC-Pipes											
ISO 6259-2	1	Machined specimen	≥115	33±2	≥15	6+0.4	wall thickness	25±1	80±5		B009 / 010
ISO 6259-2	2	By cutting die produced specimen	≥115	33±2	25±1	6+0.4	wall thickness	25±1	80±5		
Polyolefin pipes (PE, PP)											
ISO 6259-3	1	Wall thickness >5 mm (similar ISO 527-2, type 1B)	≥115	60±0,5	20±0,2	10±0.2	wall thickness	50±0,5	115±0.5		B009 / 010
ISO 6259-3	2	Wall thickness ≤5 mm (similar ISO 37, type 1)	≥115	33±2	25±1	6+0.4	wall thickness	25±1	80±5		
ISO 6259-3	3	Wall thickness >12 mm	≥250	25±1	100±3	25±1	wall thickness	20±1	165±5		B281/282
ISO 18488		Strain hardening modulus	70	16±1	20±1	4±1	0.3±0.05 or 1±0.1	-	30±0.5		

Specimen for pendulum impact tests

Standard	Type	Application	l_3 mm	l_1 mm	b_2 mm	b_1 mm	h mm	L_0 mm	L mm	Shape	Cutting die/ spare die ¹⁾
ISO 179-1	1	Charpy (from multipurpose specimen)	80±2	-	-	10±0.2	4±0.2	62+0.5 (preferred)			only molding or machining
ISO 179-1	2	Charpy, materials exhibiting interlaminar shear	25 x h (11 od. 13) x h	-	-	10 oder 15	3 (preferred)	20 x h (6 od. 8) x h			-
ASTM D 6110	-	Charpy, notched specimen	127 (5")	63.5 (2.5")	-	12.7 (1")	3...12.7 (preferred.) 6.36...12.7	101.6±0.5 (4")			molded or pressed
ISO 180	1	Izod (from multipurpose specimen)	80±2	-	-	10±0.2	4±0.2	-			-
ASTM D 256	-	Izod, notched specimen (2.5")	63.5±2	-	-	12.7±0.2 (0.5")	3...12.7 (preferred) 6.35...12.7	31.8±1 (1.25")			-
ASTM D 4812	-	Cantilever Beam Impact (unnotched)	63.5 (2.5")	-	-	12.7 (0.5")	3.17 ±0.13 (preferred)	-			-
ASTM D 4508	-	Chip impact (small specimen)	19.05 (0.75")	-	-	12.7 (0.5")	1.02...3.175 (0.04"...0.125")	-			-
DIN 53435	-	Dynstat impact (small specimen, unnotched or notched, notch type A and D)	15 ±1	-	-	10 ±0.5	1.2...4.5	-			-
ISO 8256	1	Tensile impact, notched type	80±2	30±2	10±0,5	6±0.2	-	-			D.095 / 096
	2	Tensile impact	60±1	25±2	10±0,2	3±0.05	-	10±0.2			D.101 / 102
	3	Tensile impact	80±2	30±2	15±0,5	10±0.5	-	10±0.2			D.103 / 104
	4	Tensile impact	60±1	25±2	10±0,2	3±0.1	-	-			D.097 / 098
	5	Tensile impact	80±2	50±0.5	15±0,5	5±0.5	-	10±0.2			D.105 / 106
ASTM	S	Tensile impact	63.5 (2.5")	25.4 (1")	9.53/12,7	3.18±0.03 (0.125")	3.2 (0.125")	-			D.087 / 088
D 1822M	L	Tensile impact	63.5 (2.5")	25.4 (1")	9.53/12,7	3.18±0.03 (0.125")	3.2 (0.125")	-			D.090 / 100

¹⁾ Cutting is only possible for specimen showing a hardness less than 85 Shore A. Harder materials shall be machined by use of milling machines or other convenient machinery acc. to ISO 2818.

²⁾ This specimen shape is specially designed for moulding. Cut specimens do not correspond to any standard.

³⁾ Value indicates the upper and lower tolerances.

5.2 Overview of standards and test equipment

Subject	Standard	Testing equipment	Page
Testing equipment: design, verification, accuracy, environmental conditions			
• Tensile, compression and bending machines	ISO 5893, ISO 7500-1, ASTM E 4, ISO 9513, DIN 51220		
• Impact testing machines	ISO 13802, JIS B7756, EN 10045-2, DIN 51230		
• Standard atmospheres for testing	ISO 291, JIS K 7100, ASTM D 618		
• Conditioning and test conditions for rubber	ISO 23529, DIN 53500, ASTM D 1349, ASTM D 832		
• Performing of round robin tests	ASTM E 691		
• Temperature devices for rubber testing	ISO 23529		
• Creep testing machines	ISO 7500-2		
Specimen preparation			
• Injection moulding	ISO 294-1/-2/-3/-4	Injection moulding machine	-
• Compression moulding	ISO 293, ISO 295	Moulding press	-
• Machining	ISO 2818	Cutting press, strip cutter	21
• Rubber	ISO 4661-1, ASTM D 1485, ASTM D 3183	Cutting press	21
	ISO 23529		
• Test specimen for plastics	ISO 20753		21
• Test specimen for PS	ISO 1622-2		-
Dimension measurement			
• Multipurpose specimen	ISO 527-1, ISO 16012, ASTM D 5947	Micrometer	19
• Thickness of plastic film	ISO 4593, DIN 53370, ASTM D 374, ISO 4591, ASTM E 252	Dead weight thickness gauge, balance	19
• Rubber	ISO 37, DIN 53504, ISO 23529	Dead weight thickness gauge, balance	19
	ISO 3302, ASTM D 3767		
• Cellular plastics and rubber	ISO 1923, DIN 53570	Dead weight thickness gauge, vernier caliper	19
Thermoplastic and thermosetting plastics			
• Tensile properties	ISO 527-1/-2, ASTM D 638, ASTM D 1708, EN 2747	Material testing machine	6,22
• Poissons ratio	ISO 527, ASTM E 132	Material testing machine	6,22
• Flexural properties (1 point method)	ASTM D 747	Material testing machine	22
• Flexural properties (3 point method)	ISO 178, ASTM D 790, ASTM D 5934	Material testing machine	6,22
• Flexural properties (4 point method)	ASTM D 6272	Material testing machine	22
• Compression properties	ISO 604, ASTM D 695	Material testing machine	22
• Shear properties	ASTM D 732	Material testing machine	22
• Creep behaviour, tensile	ISO 899-1, ASTM D 2990	Creep testing machine	7,27
• Creep behaviour, flexural (3 point method)	ISO 899-2, ISO 6602, ASTM D 2990	Creep testing machine	7,27
• Creep behaviour, compression	ASTM C 1181, ASTM D 2990	Creep testing machine	7,27
• Dynamic mechanical properties	EN ISO 6721-4/-5/-6, ASTM D 5023, ASTM D 5024, ASTM D 5026, DIN 53442	Servo-hydraulic testing machine	25
• Fracture mechanics	ISO 13586, ASTM E 813, ISO 17281, ASTM D 5045, ASTM D 6068, ISO 15850	Material testing machine	22
	ISO 28660		
• Ball indentation hardness	ISO 2039-1	Ball indentation hardness tester	41
• Rockwell hardness (R, L, M, E, K)	ISO 2039-2, ASTM D 785	Hardness tester	41
• Rockwell α hardness	ISO 2039-2, ASTM D 785	Hardness tester	41
• Instrumented hardness	ISO 14577-1, DIN 50359-1	Instrumented hardness tester	-
• Shore A- and Shore D-hardness	ISO 868, ASTM D 2240,	Shore hardness tester	40
• Shore B, C, 0, 00, D0	ASTM D 2240	Shore hardness tester	40,41

Subject	Standard	Testing equipment	Page
Thermoplastic and thermosetting plastics (continuation)			
• Charpy resilience	ISO 179-1, ASTM D 6110	Pendulum impact tester	8,30
• Izod resilience	ISO 180, ASTM D 256, ASTM D 4812	Pendulum impact tester	8,30
• Tensile-impact resilience	ISO 8256, ASTM D 1822	Pendulum impact tester	8,30
• Dynstat resilience	DIN 53435	Pendulum impact tester	8,30
• Dynstat flexure test	DIN 53435	Material testing machine	22
• Brittleness temperature resilience	ISO 974	Pendulum impact tester	8,30
• Instrumented impact test, Charpy resilience	ISO 179-2	Pendulum impact tester	8,30
• Falling dart test	ISO 6603-1, ASTM D 5628, ASTM F 736	Dropp weight tester	8,33
• Multiaxial impact	ISO 6603-2, ASTM D 5420, DIN 53443-2, ASTM D 3763, ASTM D 5628	Dropp weight tester, High-speed testing machine	8,33
• High speed tensile test	ISO 18872	High-speed testing machine	8,33
• Melt Flow Rates (MFR, MVR, FRR)	ISO 1133, ASTM D 1238, ASTM D 3364	Extrusion plastometer	34
• Determination of density	ISO 1183-1	Density kit	-
• Vicat softening temperature (VST)	ISO 306, EN 2155-14, JIS K 7206, ASTM D 1525, BS 2782 - Meth. 121 C	Vicat VST instrument	7,36
• Heat Deflection Temperature (HDT)	ISO 75-1/-2/-3, ASTM D 648, BS 2782 - Meth. 120 C	HDT instrument	7,36
Rubber and elastomers			
• Tensile properties	ISO 37, ASTM D 412, DIN 53504	Material testing machine	16,22
• Tensile, rubber condoms	ISO 4074	Material testing machine	22
• Test methods for rubber threads	ISO 2321, ASTM D 2433	Material testing machine	22
• Tension set	ISO 2285, ASTM D 412	Material testing machine	22
• Compression properties	ISO 7743, ASTM D 575	Material testing machine	22
• Compression set	ISO 815, ASTM D 395, ASTM D 1229	Material testing machine	17
• Tear properties, Graves method	DIN 53515, ASTM D 624, ISO 34	Material testing machine	16,22
• Tear properties, trouser, angle, crescent	ISO 34-1	Material testing machine	16,22
• Tear properties, Delft	ISO 34-2	Material testing machine	16,22
• Adhesion properties	EN 28033, ISO 814, ISO 5600, ISO 5603, ISO 8033, ASTM D 429, ASTM D 1871, ASTM D 413, ISO 813, DIN 53531-2	Material testing machine	18,22
• Analysis of multi peak traces	ISO 6133		-
• Shear properties	ISO 1827	Material testing machine	22
• Creep, relaxation	ISO 3384, ISO 8013, ISO 6914	Material testing machine	22
• Friction properties	ISO 15113	Material testing machine	22
• Visko-elastic properties	ISO 4664, DIN 53513, DIN 53 535	Servo-hydr. testing machine	17,25
• Fatigue	ASTM D 430, ASTM D 4482		17,25
• Test methods for O-rings	ASTM D 1414		
• Requirements for pipe joint seals	EN 681		
• IRHD hardness	ISO 48-1/-2/-5, ASTM D 1415	IRHD hardness tester	17,41
• Shore A and D hardness	ISO 48-4, ASTM D 2240,	Shore hardness tester	17,40
• Shore B, C, A0, D0, 00, 000, 000-S, R	ASTM D 2240	Shore hardness tester	17,41
• Abrasion resistance	ISO 4649, DIN 53516	Abrasion tester	17
• Rebound resilience	ISO 4662, DIN 53512, ASTM D 1054	Rebound resilience tester	32
• Density	ISO 2781, ASTM D 792, DIN 53479	Density kit	-

Subject	Standard	Testing equipment	Page
Rubber or plastic coated fabrics			
• Tensile properties	ISO 1421, ASTM D 751	Material testing machine	22
• Adhesion properties	ISO 36, ISO 4637, ISO 4647, ASTM D 413	Material testing machine	18,22
• Blocking resistance	ISO 5978, EN 25978	Material testing machine	22
• Tear resistance	ISO 4674, ASTM D 751, DIN 53356	Material testing machine	22
Rigid cellular plastics			
• Test methods	ISO 9054, ISO 7214		-
• Tensile properties	ISO 1926, ASTM D 1623, DIN 53430, EN 1608	Material testing machine	13,22
• Tensile strength perpendicular to faces	EN 1607, DIN 53292	Material testing machine	13,22
• Flexural properties	ISO 1209-1/-2, JIS K 7221, EN 12089	Material testing machine	22
• Shear strength	ISO 1922, DIN 53427, DIN 53294, EN 12090, ASTM C 273	Material testing machine	22
• Compression properties	ISO 844, ASTM D 1621, EN 826	Material testing machine	13,22
• Compression creep test	ISO 7616, ISO 7850, EN 1606	Material testing machine	22
• Thickness measurement	EN 12431	Material testing machine	22
• Impact strength, Charpy	ISO 179	Pendulum impact tester	28
• Density	ISO 845, ASTM D 1622	Balance	-
Flexible cellular polymeric materials			
• Tensile properties	ISO 1798, ASTM D 3574-E	Material testing machine	13,22
• Compression properties	ISO 3386-1, ISO 3386-2, ASTM D 3574-C, ASTM D 1055	Material testing machine	12,22,24
• Indentation hardness	ISO 2439, DIN 3386, DIN 53579-1, ASTM D 3574-B, ASTM D 3579	Material testing machine	12,22,24
• Compression load deflection	ISO 11752	Material testing machine	12,22,24
• Tear strength, trouser specimen	ISO 8067, ASTM D 3574-F	Material testing machine	13,22
• Creep in compression	ISO 10066, ISO 1856	Material testing machine	22
• Rebound resilience	DIN 13014, ISO 8307, ASTM D 3574	Rebound resilience tester	32
• Constant load pounding	ISO 3385		12,24
• Accelerated ageing tests	ISO 2440		-
• Dynamic cushioning performance	ISO 4651	Drop weight tester	-
• Apparent density	ISO 845, ASTM D 3574-A	Balance	-

Subject	Standard	Testing equipment	Page
Thin sheetings and films			
• Tensile properties	ISO 527-3, ASTM D 882, ASTM D 5323	Material testing machine	10,22
• Tear resistance, Graves, angle specimen	ISO 34, DIN 53515	Material testing machine	22
• Tear resistance, trouser specimen	ISO 6383-1, ASTM D 1004, ASTM D 1938	Material testing machine	22
• Tear resistance, trapezoidal specimen	EN 495-2, DIN 53363	Material testing machine	22
• Blocking strength	ISO 11502, DIN 53366, ASTM D 3354	Material testing machine	22
• Puncture tests	EN 14477, ASTM D 5748, ASTM F1306	Material testing machine	12,22
• Tensile-impact resilience	ISO 8256, ASTM D 1822	Pendulum impact tester	30
• Impact resistance, free falling dart	ISO 7765-1/-2, ASTM D 4272	Drop weight tester	33
	ASTM D 1709, ASTM D 3763, JIS K 7124, DIN 53373		
• Coefficients of friction	ISO 8295, ASTM D 1894, JIS K 7125, DIN 53375, DIN 55426	Material testing machine	10,22
Plastic piping			
• Specifications for pipes	EN 1555, EN 1852		
• Tensile properties	ISO 6259-1/-2/-3, ISO 8521, ISO 8513, ISO 8533, ASTM D 2105, ASTM D 2290, EN 1393, EN 1394	Material testing machine	9,22
• Strain hardening modulus	ISO 18488	Material testing machine	9,22
• Compression properties	EN 802, EN 1446, ISO/DIS 4435, DIN 53769-3, ASTM D 2412	Material testing machine	9,22
• Flexural strength	EN 12100	Material testing machine	22
• Creep test, creep ratio	ISO 9967, ISO 7684, EN 761, EN 1862, DIN 16961-2	Material testing machine	9,27
• Ring stiffness	ISO 9969, ISO 13967, ISO 10466, ISO 10471, EN 1228, ASTM D 5365	Material testing machine	9,22
• Ring flexibility	ISO 13968		
• Cyclic compression test	ASTM D 2143		
• Vicat softening temperature	EN 727	Vicat VST-Gerät	36
• Impact characteristics	EN 744, EN 1411, EN 12061, ISO 3127, ASTM D 2444, ISO 7628	Drop weight tester/ Pendulum impact tester	
• Melt flow index	ISO 4440-1/-2	Extrusion plastometer	34
Adhesives			
• Tensile properties (butt joints)	ISO 6922, EN 26922, EN 1940, EN 1941, EN 14410, prEN 15870	Material testing machine	11,22
• Peel resistance	ISO 4578, ISO 8510-2, ISO 11339, EN 28510-1/-2, EN 1464, EN 1939, EN 60454-2, Finat FTM 1-4	Material testing machine	11,22
• Contact adhesion	EN 1945, Finat FTM 9		
• Shear strength	ISO 4587, ISO 10123, EN 1465, ISO 11003, ISO 13445, ASTM D 3163, ASTM D 3164, ISO 9311-2, EN 15337	Material testing machine	11,22
• Bending-shear strength	ISO 15108	Material testing machine	11,22
• Creep properties	ISO 15109	Material testing machine	22
• Shear impact strength	ISO 9653, EN 29653		
• Fatigue properties	ISO 9664	Servo-hydr. testing machine	27
• Resistance to flow	ISO 14678		
• Energy release rate, mode I, DCB	ISO 25217	Material testing machine	22
• Plastic-metal assemblies	ISO 19095-1 to -4	Material testing machine	22

Zwick / Roell

ZwickRoell

August-Nagel-Str. 11

D-89079 Ulm

Phone +49 7305 10 - 0

Fax +49 7305 10 - 11200

info@zwickroell.com

www.zwickroell.com

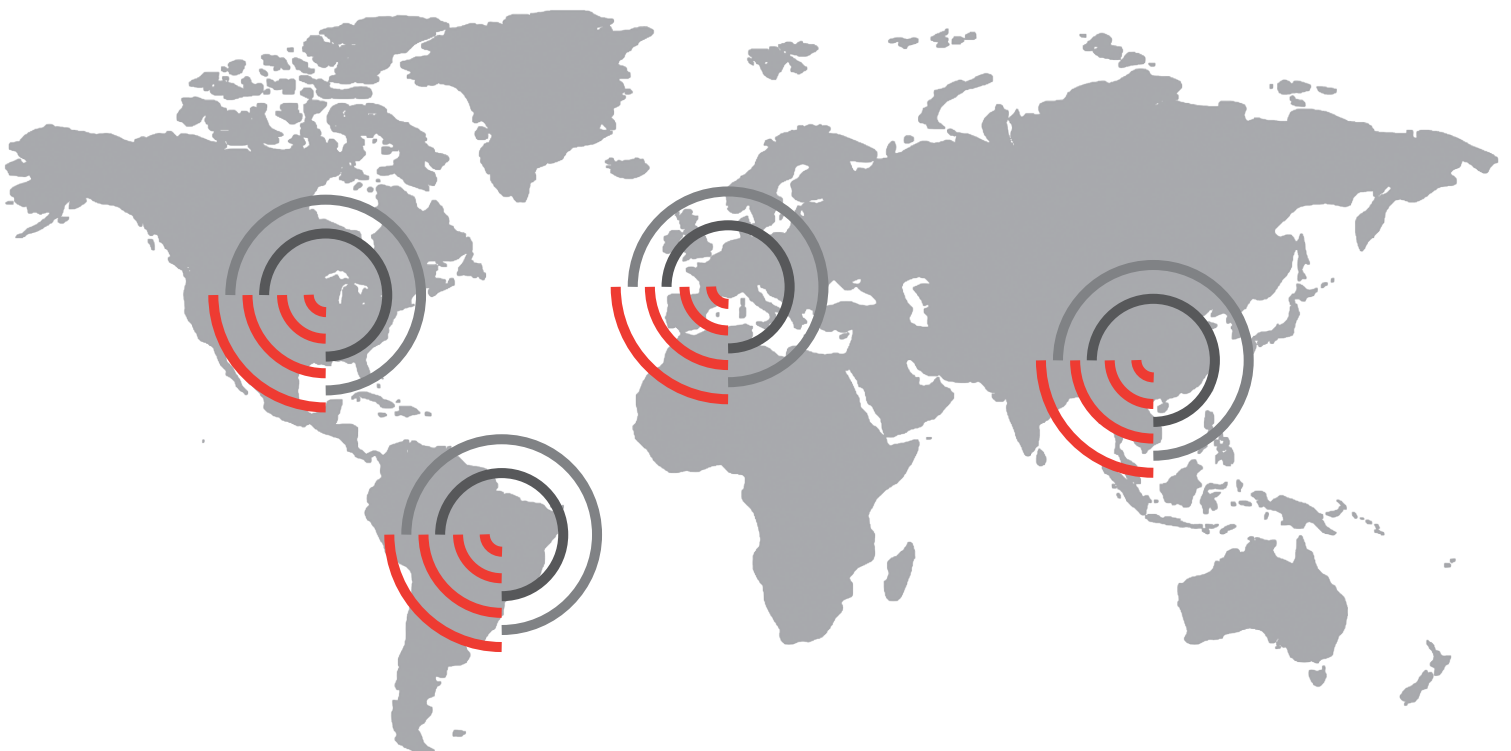

Find your local company – worldwide
www.zwickroell.com