

Testing Machines and Systems for Composites

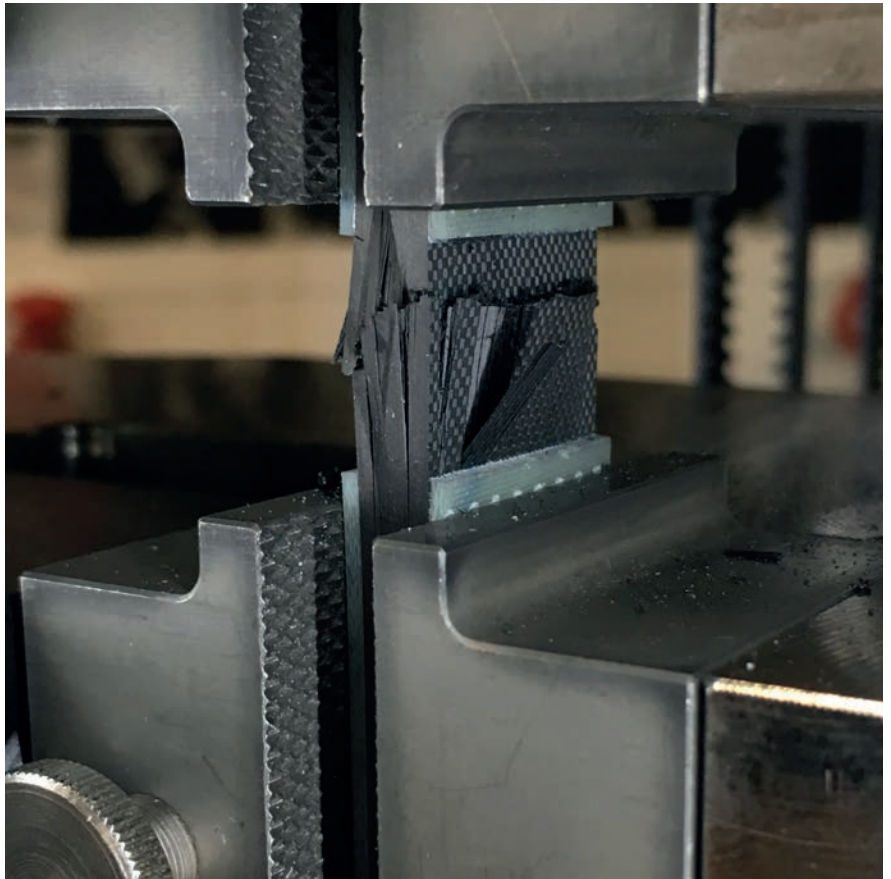



The ZwickRoell Group

Contents	Page
The ZwickRoell Group	3
Your partner for composites testing	4

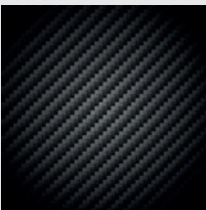

Testing Applications for Fiber-Reinforced Composites

Application	Variation	Page
Testing applications overview		5
Tensile tests	Tensile, OHT, FHT	6
Compression tests	Compression, OHC, FHC	8
Compression after impact	CAI	10
Shear tests	IPS, V-notched shear, rail-shear, lap-shear, ILSS	11
Flexure tests	3-point, 4-point	15
Energy release rate	G_{Ic} , G_{IIc} , Mixed Mode	16
Pin-bearing strength	Single shear tension, double shear tension	17



Products and Services for Composites Testing

Products	Type	Page
Electromechanical testing machines	Table-top and floor-standing models	18
High-capacity machines	Nominal loads between 300 kN and 1200 kN	20
Temperature chambers		21
Modular testing system for composites	Temperature range of -70 °C to +250 °C	22
Fatigue testing machines	Servohydraulic and electrodynamic	24
Automation	Robotic testing systems for composites applications	25
Testing instruments	Drop weight testers	26
Load cells		27
Testing software	testXpert III	28
Extensometers	Contact and non-contact measuring systems	30
Exact alignment of the testing machine	Alignment	33
ZwickRoell Service		34



Standards Overview

Standards	Page
Calibration, conditioning, specimen production	37
Long-fiber-reinforced composites	37
Sandwich, core and honeycomb type composites	38

ZwickRoell — Passion and expertise

Our company philosophy is founded on a passionate commitment to our customers. We work hard to ensure customer satisfaction by having over a third of our employees engaged in service and support.

As a family-owned company with a tradition dating back 150 years, we place great value on honesty and fairness. Over the years an ethos of close collaboration based on mutual trust between our partners, suppliers and customers has evolved, something that we all value highly.



Global Loops statue at the ZwickRoell headquarters in Ulm, Germany

The foundation for a successful partnership: innovative employees as well as innovative products



Always at your service

Over 1100 people are employed at our headquarters in Ulm, Germany. Many of them have been with us for years — decades even. Their knowledge, ability and commitment are what lies behind the global success of the ZwickRoell Group.

We are present in over 50 countries around the world.

The right solutions

Whether for static materials testing or the various forms of fatigue testing — we have the right solutions. We offer products for hardness testing as well as instruments for impact testing and for melt index determination.

And for that rare occasion where we don't have a ready-made solution to suit your needs, our experts will find the right solution for you, from the smallest adaptation to a fully automated testing system or a test stand for special purposes.

ZwickRoell – your partner for composites testing

System-based testing solutions

Over the last few years, experience and commitment have enabled ZwickRoell to develop the most comprehensive composites testing system worldwide. Despite of the complexity involved, the modular design of the test equipment combines ease of operation with a wide range of reconfiguration options for different types of tests. This allows you to attain reliable test results and perfectly accurate measurements that you can trust.

Another benefit of the modularity: our testing machines can be easily retrofitted for new test types for years to come.

Experts and standards

ZwickRoell has around 100 employees engaged in developing testing machines, instruments and software packages in line with the requirements of modern standards.

Specialists in our Applications Testing Laboratories test new products and perform testing services for our customers to help validate the suitability for the required test types.

Through the participation of approximately ten employees in various standards committees, including those relating to testing machines, aerospace, plastics and fiber-reinforced composites, ZwickRoell is closely involved in the development of standards at both the national and international level.

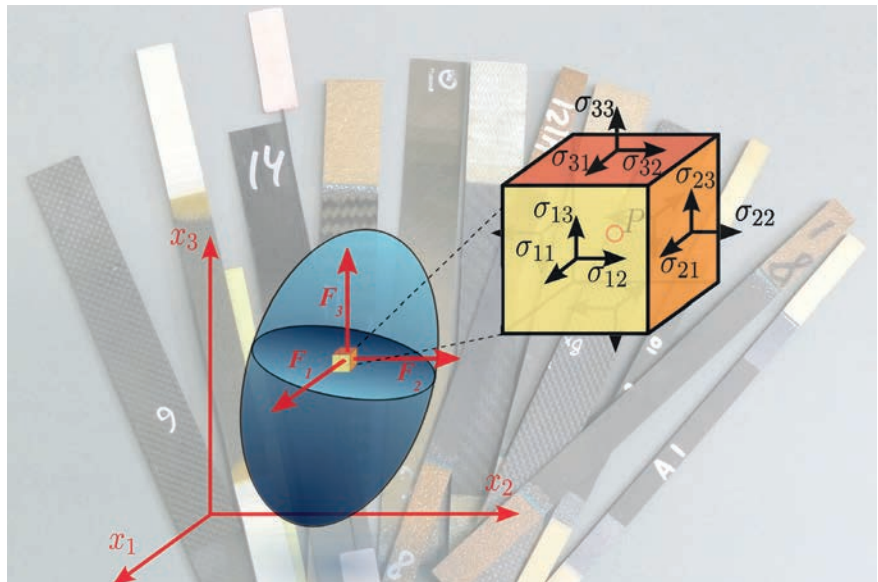

Fig. 1: ZwickRoell products characterize composite materials in all normal and shear directions.

Product quality

Our testing machines used to test brittle materials are subject to stringent requirements with regard to quality of the drive and guide components, their axiality, absence of play and, in the case of compression tests also their stiffness. We meet these requirements by using high quality standard components, by making careful materials selections and by implementing well-thought-out design principles.

Modern production methods, experienced employees

Our testing machines are produced using the latest manufacturing methods in a 7000 m² production area at the ZwickRoell headquarters in Ulm, Germany. Modern machinery plus assembly by a competent, highly experienced workforce ensures consistent high quality. Many of our employees have been with the company for years, with some being second or third generations at ZwickRoell.



Fig. 2: ZwickRoell products meet all current standards.

Calibration and alignment - a lot depends on it

Before being delivered, all test equipment is calibrated by ZwickRoell according to current ISO standards. This ensures that all sensors measure correctly. For testing machines that are used for testing of brittle materials such as unidirectional fiber reinforced composites, ceramics or brittle metals, an alignment measurement and adjustment can be performed.

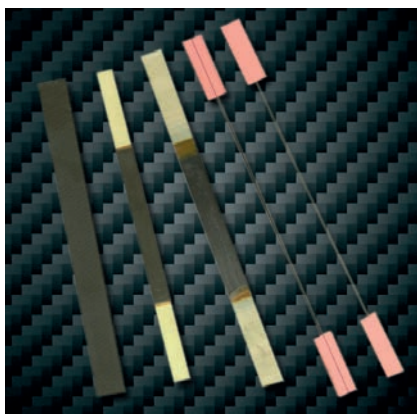

Testing of fiber-reinforced composites

Fiber-reinforced composites exhibit orthotropic behavior and substantial elasticity in their range of use. Therefore, measurement of the stress-strain behavior in all normal and shear directions is common.

Standardization has developed a series of methods that characterize composite materials under a wide variety of load conditions.

Performing these tests requires precise tools and exact force application with excellent alignment, achieved by means of special alignment fixtures.



Fig. 1: ZwickRoell offers the ideal machine configuration for every test. Two test areas, one on top of the other, or the option of additional side test areas eliminate the need for modifications.

Tensile testing on fibers and filament strands

Tensile tests on unidirectionally reinforced materials, such as pultruded rods or resin coated filament bundles require a great deal of experience in the selection of the suitable specimen grips.

In many cases the specimen must be protected with cap strips to avoid premature fiber breakage in the gripping area. However, there are solutions that eliminate the need for the cap strips and the cost and effort involved in the associated specimen preparation, leading to a true improvement in efficiency.

ZwickRoell offers a very wide selection of specimen grips and jaw inserts. Pre-testing is performed on customer specimens in ZwickRoell's Applications Testing Laboratory to determine the optimal machine configuration.

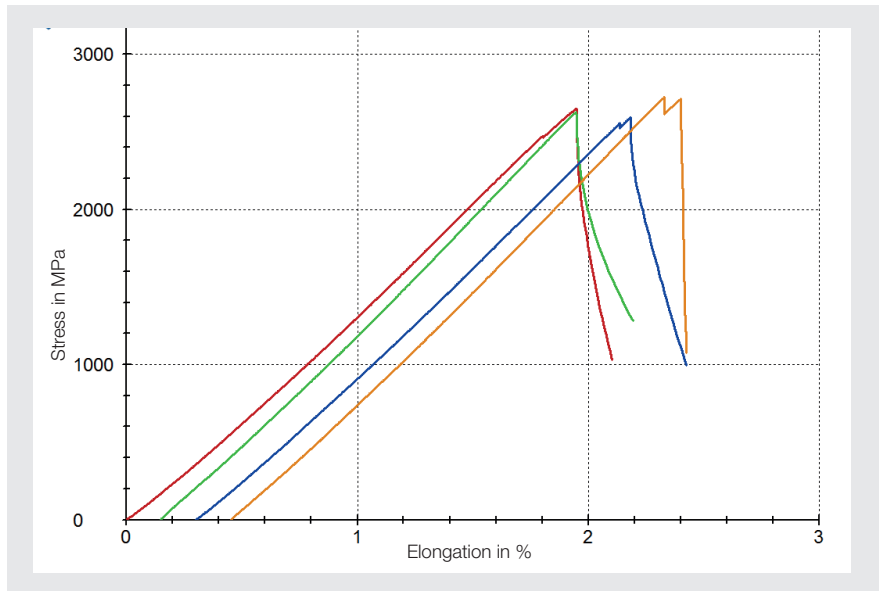

Fig. 2: testXpert III ensures the correct test sequence — fully automated.

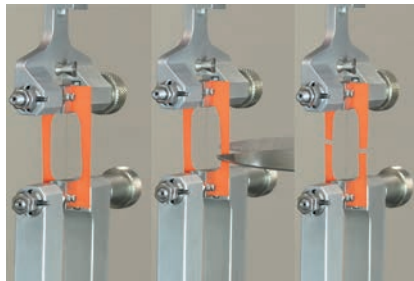

Fig. 3: Individual filaments are gripped inside paper frames.



Fig. 1: Pultruded GFRP round specimen, gripped without cap strips. Right: Valid fiber breakage in the range of the free grip-to-grip separation through soft gripping force application.

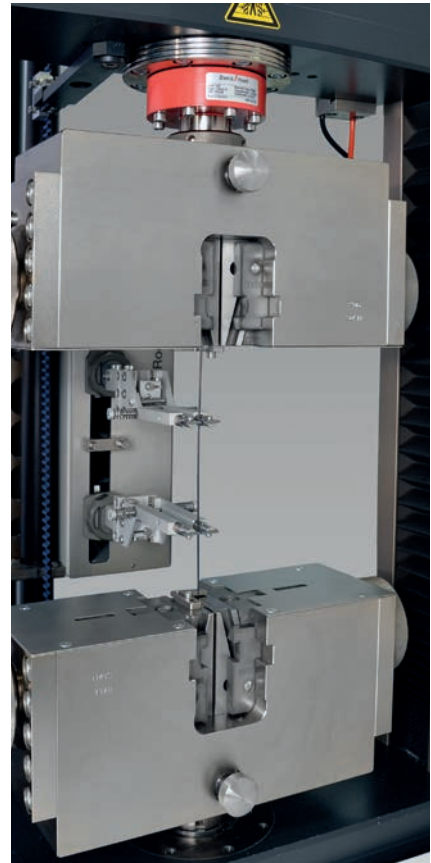

Fig. 4: Testing of resin coated carbon fiber filament strand.

Tensile tests and notch tensile tests on laminates

Tensile tests on unidirectional laminates require perfect alignment of the testing machine, suitable specimen grips and accurate extension measurement.

Multi-directional laminates are often tested with larger specimen cross sections. Because of their progressive damage behavior they are less alignment-sensitive.

ZwickRoell offers solutions for many different requirements: simple mechanical wedge grips, as well as flexible wedge screw and hydraulic grips with connection system for compression, flexure and shear devices.

For determination of the specimen extension, strain gauges, clip-on extensometers and convenient, as well as damage-resistant mechanical and optical extensometers are available.

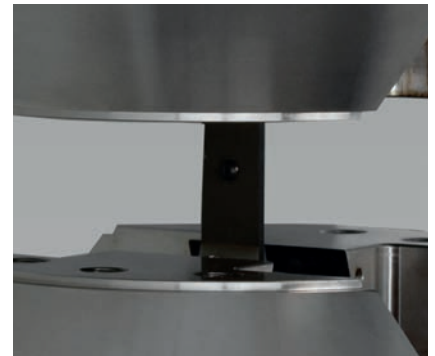
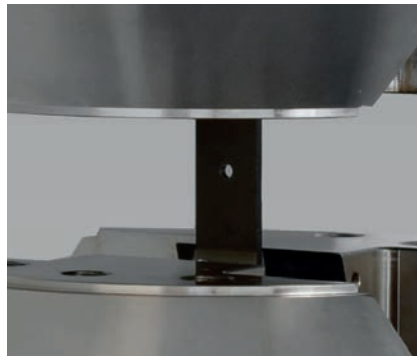
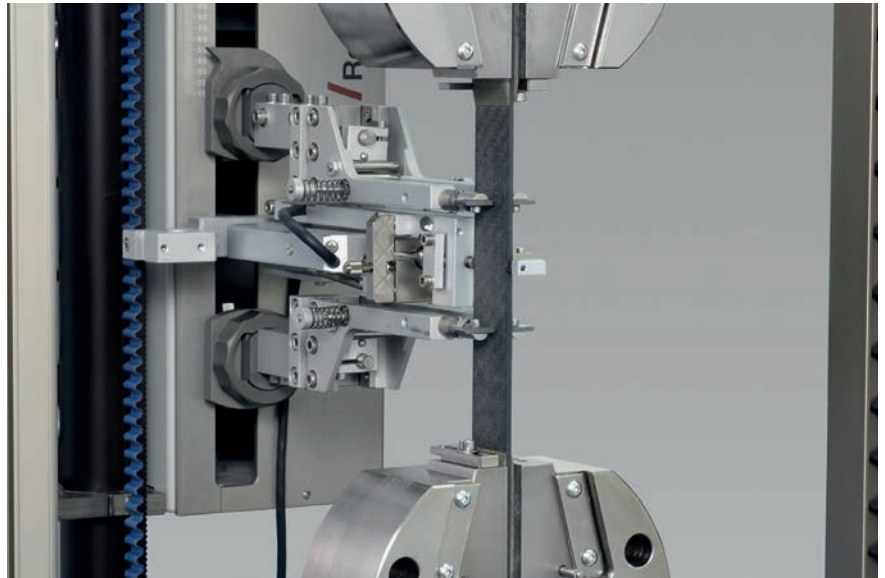

Fig. 2: Tensile tests are performed in fiber direction (0°), perpendicular (90°) or for multidirectional laminates. For multidirectional laminates, open-hole-tension (OHT) and filled-hole-tension (FHT) are common as well.

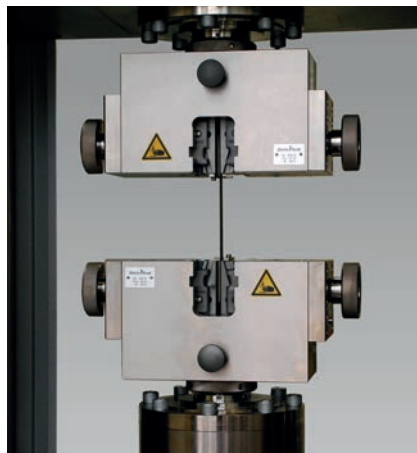
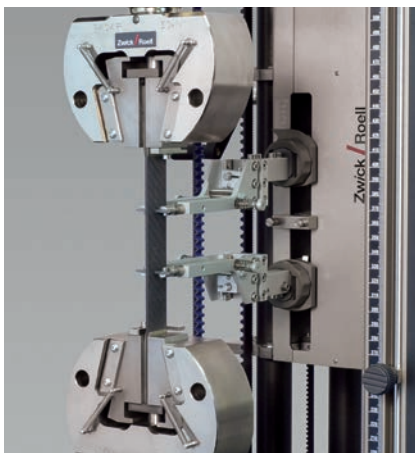

Fig. 1: For testing of laminates, centrally closing wedge grips, side adjustable wedge screw grips, as well as hydraulic, parallel closing body-over-wedge grips with a wide selection of jaws, are available.

Compression tests, OHC, FHC

Various types of compression tests, each with its own specific fixture, have been developed over the last five decades.

These fixtures are usually distinguished by the type of compression loading employed.

End loading between two compression platens is simplest as far as the fixture is concerned, but it requires a high level of accuracy in machining the specimen ends. The method delivers reliable compression modulus values, but often results in premature failure and therefore in low measured compressive strengths.

Force application through clamping (shear loading) is ideal for the measurement of higher strengths. Older ASTM standards defined the Celanese compression fixture, which was very sensitive to variations in specimen thickness. The EN standard solved this problem by using flat wedges in place of cones in the grips.

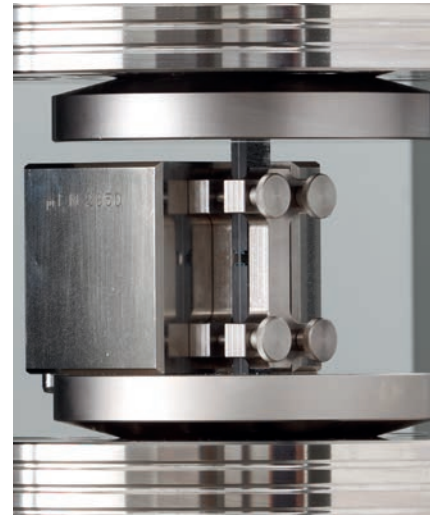

Fig. 2: End loading compression fixture to prEN 2850 and ASTM D695 (Boeing modified). The support block is centered to the compression axis using stops.

The HCCF manufactured by Zwick-Roell represents a significant improvement. The parallel hydraulic gripping principle prevents jaw movements during the test, resulting in a higher proportion of valid tests. The HCCF can be used for shear loading at lower forces and in combined shear/end loading for high forces. It is also suitable for open and filled hole compression

tests (OHC, FHC) to the Airbus standard.

Alignment errors, which are most often caused by specimen preparation, are visible before the actual load application and can be corrected.

In 2011 the HCCF was approved by Airbus for tests to AITM 1.0008.

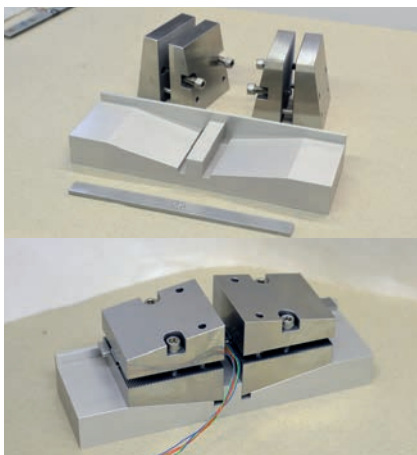

Fig. 1: Manual IITRI compression fixture to ASTM D3410: specimens and wedge jaws are mounted in an adjustment device and aligned, and tested in a guided tool.

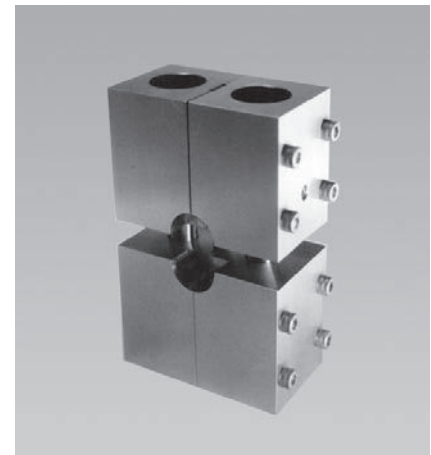
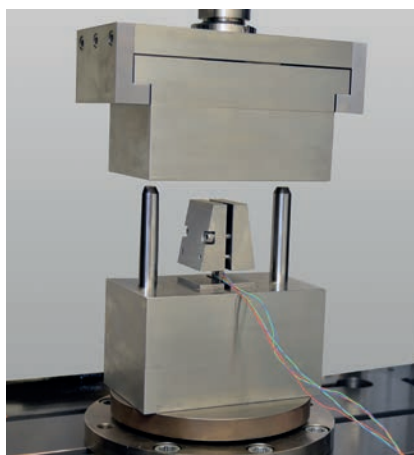

Fig. 3: Manual combined loading compression fixture to ASTM D6641 (© Wyoming Test Fixtures, Inc.)

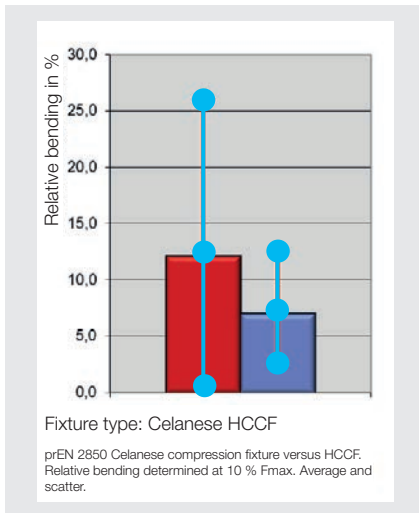

Fig. 1: Significantly improved bending and reduced measured value scatter with the HCCF.

Open hole compression (OHC) and filled hole compression (FHC) tests to ASTM and Boeing standards are carried out on long specimens using anti-buckling supports.

ZwickRoell offers reliable strain measurement via strain gauges, as well as double-sided clip-on extensometers, which are perfectly guided between the HCCF clamping jaws.

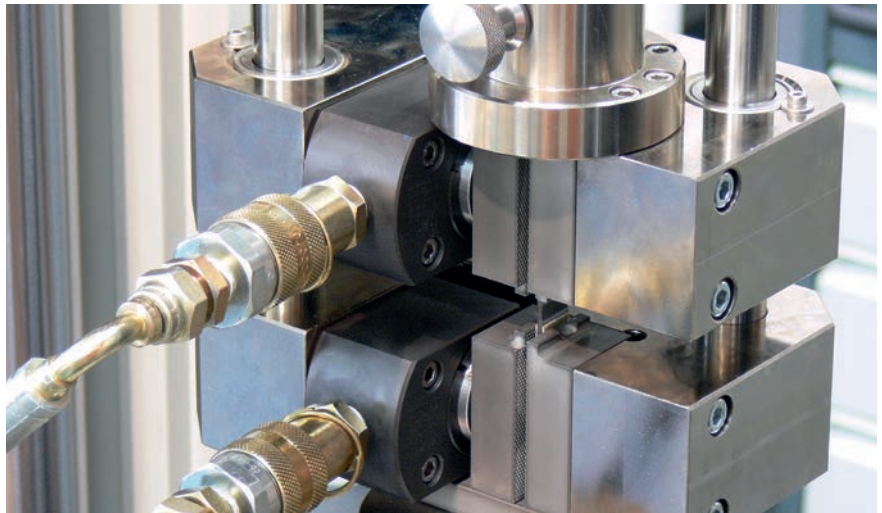

Fig. 3: The HCCF, Hydraulic Composites Compression Fixture, is used for shear loading and combined loading compression tests.

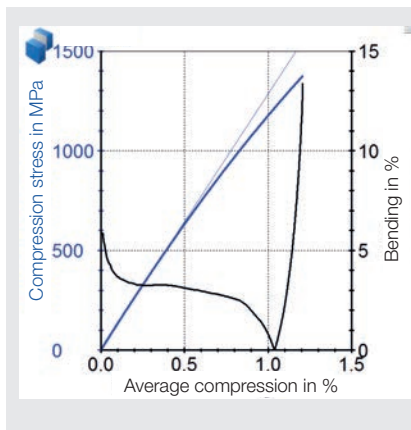

Fig. 4: testXpert III stress-strain diagram with monitoring of relative bending

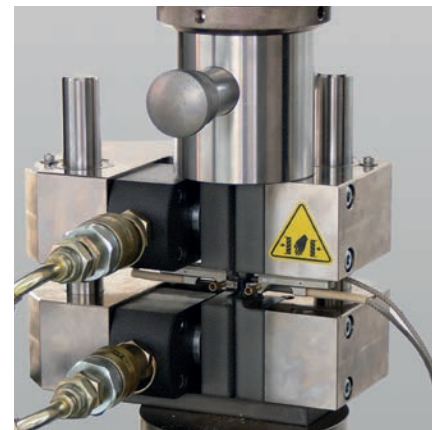

Fig. 6: Various standards allow for the use of clip-on extensometers.

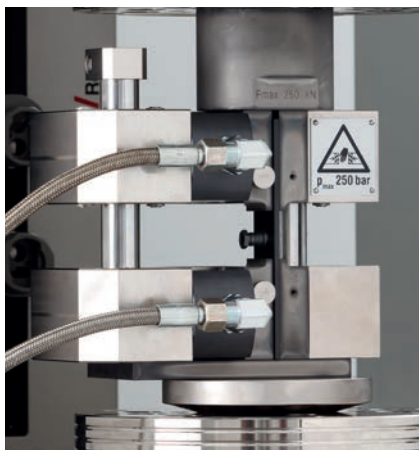

Fig. 2: The HCCF is also suitable for OHC and FHC.



Fig. 5: OHC and FHC compression tests to ASTM require an anti-buckling support, which is used for shear loading with hydraulic specimen grips, and with end loading between compression platens.



Compression after impact (CAI)

For a CAI test the compressive residual strength of a laminate after impact damage is determined. With this test, conclusions are drawn about the damage tolerance of a multidirectional composite laminate.

The instrumented drop weight tester HIT 230F with its adjustable drop height up to 1 m and the integrated speed measurement on the point of impact is in exact agreement with the requirements for pre-damaging of CAI specimens.

The modular weight set allows for accurate setting of the damage energy. A special setup avoids multiple impacts. The impactor (16 mm diameter) is instrumented and generates a force-travel diagram through the convenient testXpert III testing software, which provides indications of the damage progression.

In the subsequent compression test, the compressive residual force is determined. For ISO, EN and Airbus standards the specimen is gripped at the top and the bottom in the compression fixture, while for ASTM, DIN and Boeing standards it is only guided.

Strain gauges are applied to monitor bending and buckling.

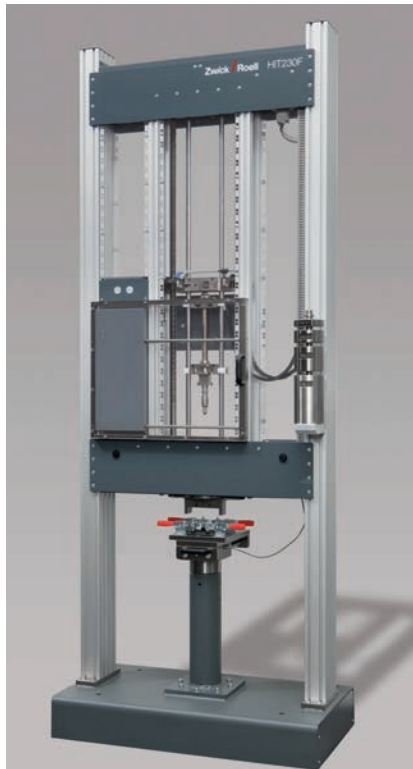

Fig. 1: HIT 230F drop weight tester with accessories for CAI pre-damaging



Fig. 2: During the compression test, the compressive residual strength of the specimen, and with that its damage tolerance, is determined. (Bottom: compression fixture to ASTM, DIN, Boeing; top: compression fixture to ISO, EN, Airbus.)



Fig. 3: Secure mounting of the CAI specimen in the drop weight tester

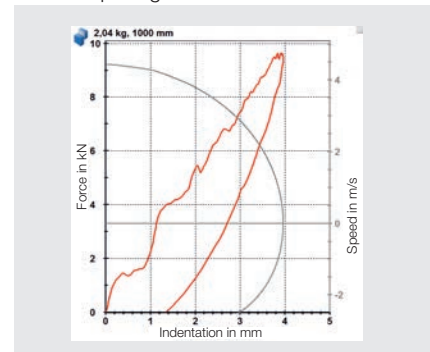
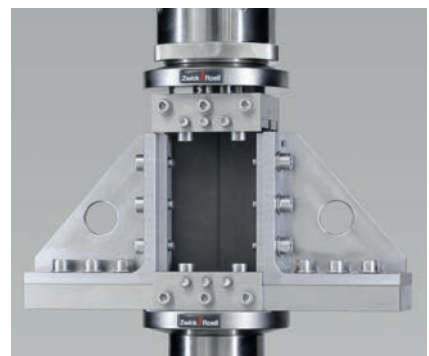
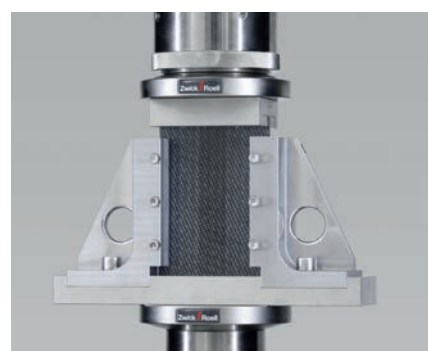

Fig. 4: The instrumentation produces a force-travel-speed diagram.



In-plane shear (IPS), $\pm 45^\circ$ tensile test

In this shear test, the fiber direction is $\pm 45^\circ$ to the tensile axis of the specimen.

In a tensile test the fibers can slide against each other, causing deformation of the matrix.

The shear strain is determined from the longitudinal and transverse strain of the specimen. For this, ZwickRoell offers several solutions:

- Measurement with two strain gauges
- Measurement with biaxial clip-on extensometer
- Measurement with automatic makroXtens extensometer and additional transverse strain extensometer
- Measurement with biaxial videoextensometer

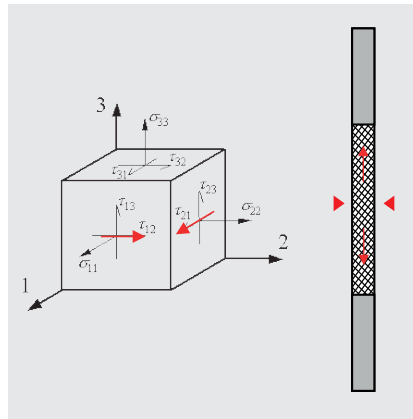

Fig. 2: The $\pm 45^\circ$ laminate structure allows for the measurement of shear properties.



Fig. 3: Measurement of shear strain with strain gauges

testXpert III displays the shear stress/shear strain curve according to the standard and calculates characteristic values including shear modulus (G_{12}) and shear strength (τ_{12M}).

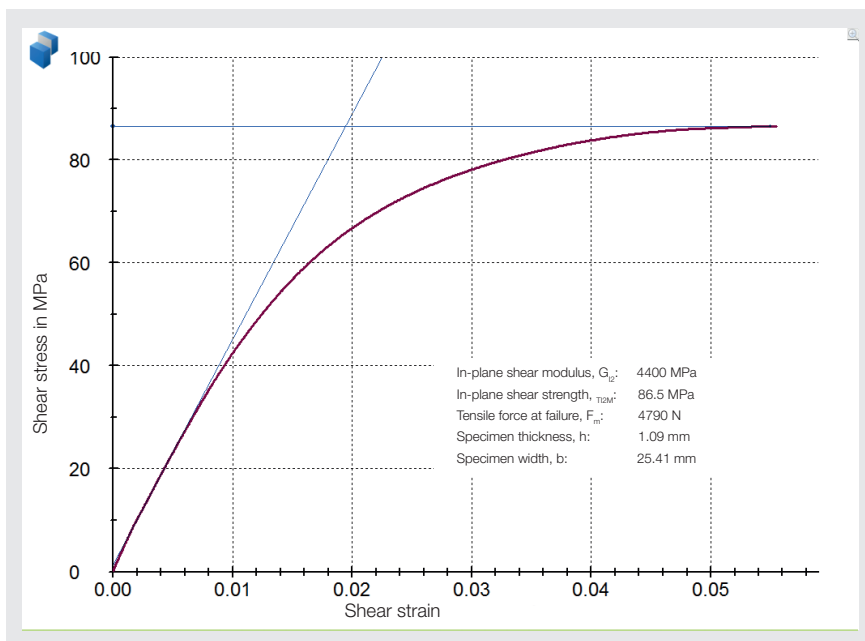

Fig. 1: The shear modulus is determined between two shear strains, e.g. 0.1 % and 0.5 % to ISO 14129 or 0.05 % and 0.25 % to prEN 6031 and AITM.

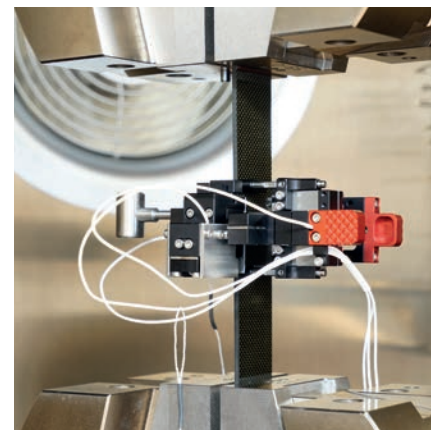

Fig. 4: Measurement of shear strain with biaxial clip-on extensometer

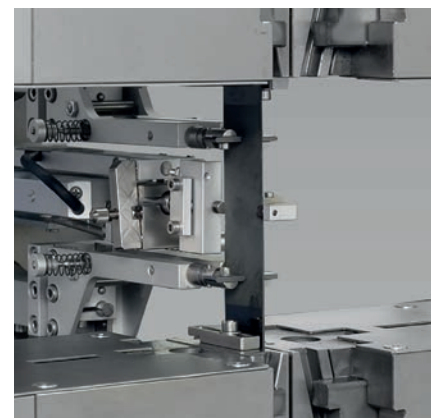

Fig. 5: Measurement of shear strain in two planes with the makroXtens

V-notch shear test

With the V-notch shear test, shear properties of laminates made of unidirectional fiber composites, woven or braided fabrics can be determined.

There are two methods that are differentiated based on the size of the specimen and the type of load application. For the V-notch shear test to ASTM D7078 the specimen for the evaluation of coarser fiber architectures is larger and is gripped on the specimen surface. For the losipescu method to ASTM D5379 the load is introduced by clamping the specimen edges.

The notch ensures concentration of the shear stresses in the smallest cross section.

Shear strain is measured in this shear plane, for example using strain gauges with short grid lengths.

A fixture with manual gripping via screws is available for the V-notch method to ASTM D7078.

The losipescu method includes axial guidance of the specimen holders, providing a shear plane virtually free of bending moments.

The double guide on one part of the fixture facilitates the installation of the specimen and prevents an out-of-plane deformation of the specimen during the test.

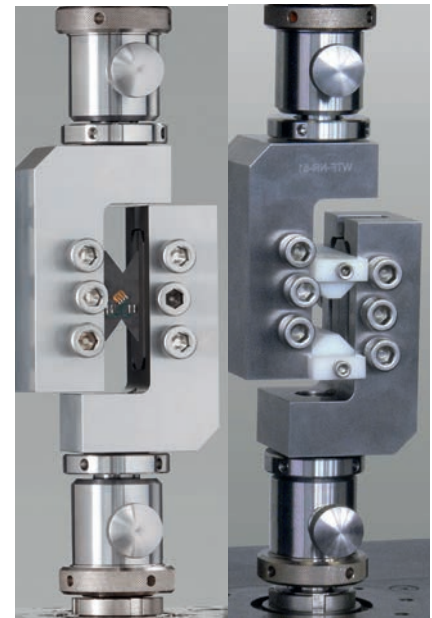

Fig. 2: V-notch shear fixtures to ASTM D7078 with manual clamping (left) and stops for specimen alignment (right)

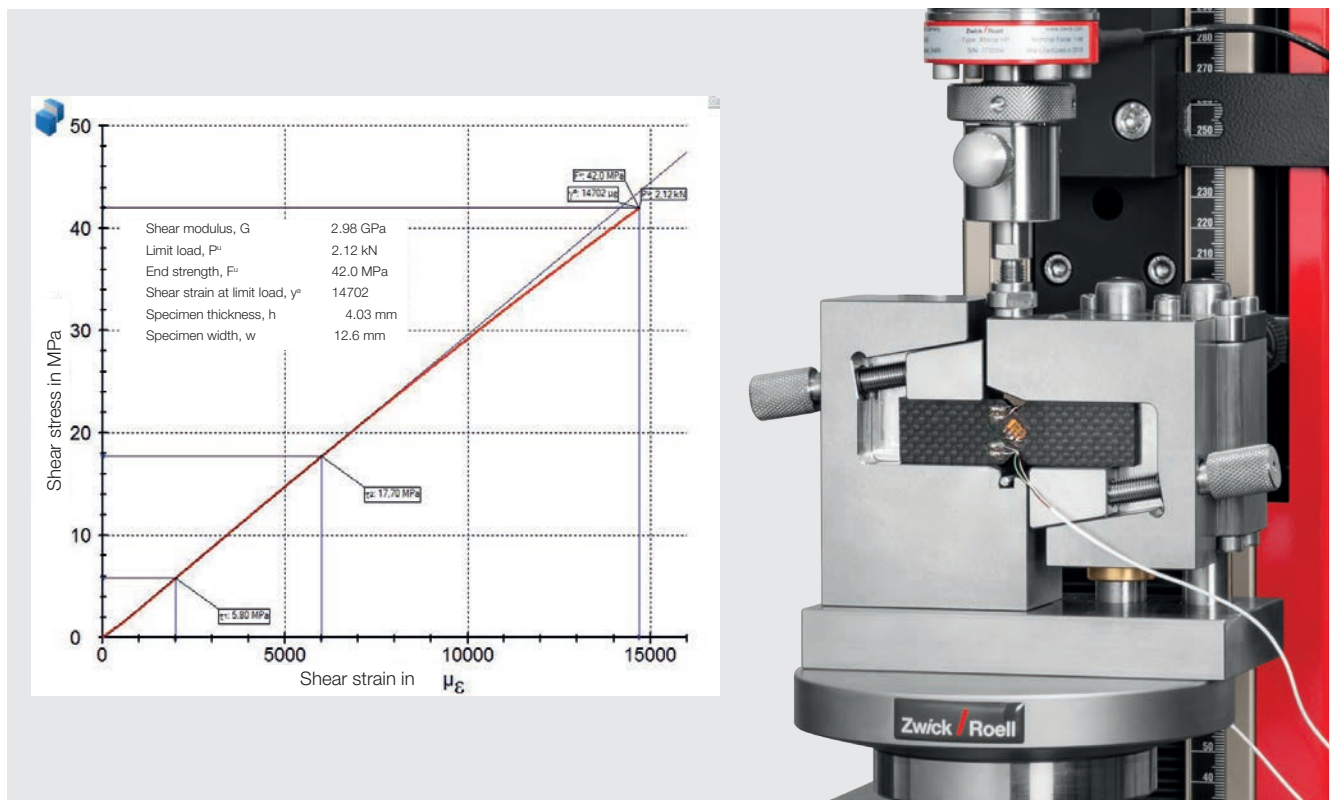

Fig. 1: losipescu method for the V-notch shear test. testXpert III provides accurate determination of shear stresses, shear strain and individual characteristic values.

Rail shear method

ASTM provides additional methods for in-plane shear testing on unidirectional laminates and wovens, for which the test plates are mounted on rails.

The measurement values include shear stress and strength, shear strain, which is determined with strain gauges, as well as the shear modulus.

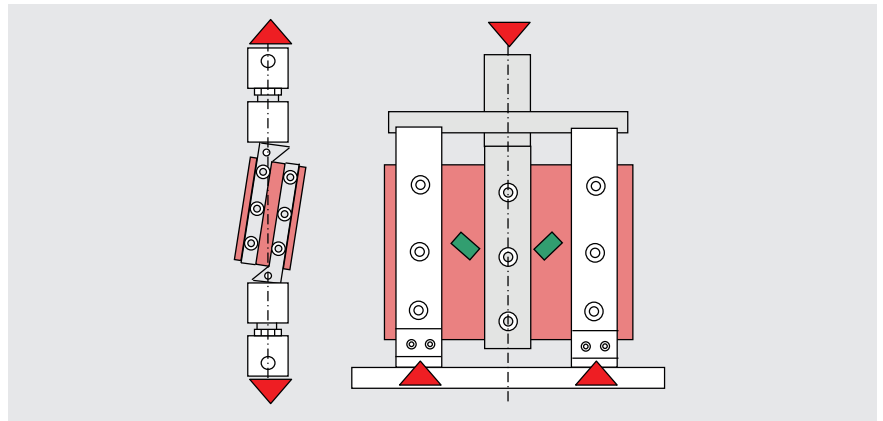

Fig. 1: Rail shear method to ASTM D4255, two-rail shear in tensile test (left), three-rail shear in tensile or compression test (right)

Shearing through overlapping (lap-shear)

This test method is commonly used for measurement comparison of the shear strength of adhesions or between laminate planes.

With the use of a high-resolution extensometer, the shear strain can also be measured if the adhesive layer thickness is known.

Correct test results are achieved with exact alignment of the specimen grips, which operate mechanically, pneumatically or hydraulically. Side adjustment of the jaws is required for simple single lap specimens.

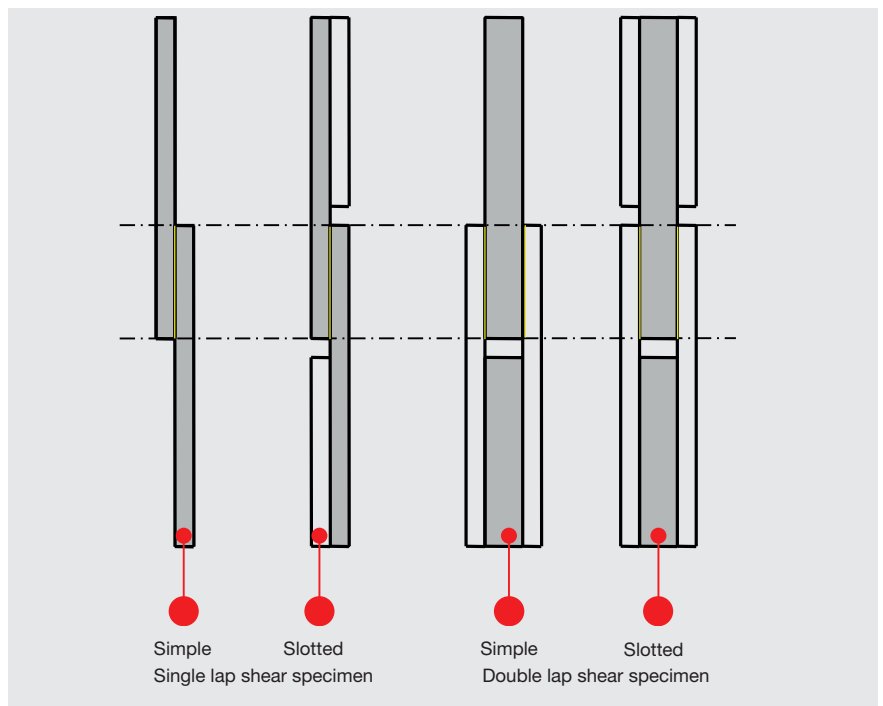

Fig. 2: Shear tests through overlapping are performed with single or double lap shear specimens, in simple or slotted version.

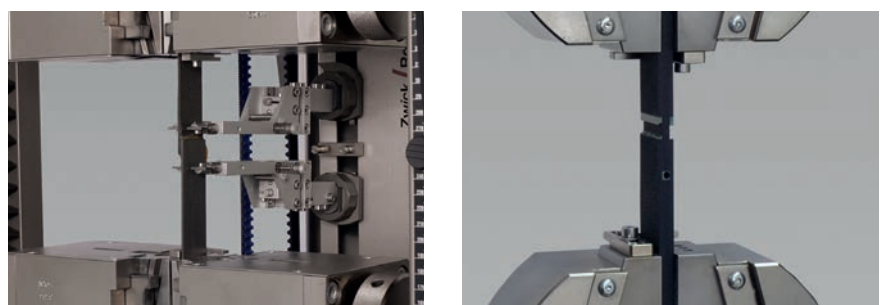

Fig. 3: For testing of simple single lap shear specimens (left), the specimen grip must have a side adjustment; right: slotted specimen.

Interlaminar shear strength (ILSS) using the short-beam shear method (SBS)

In this test the distance of the supports in relation to the specimen thickness is small. As a result the specimen is subjected to a shear load and broken.

The ILSS test fixture is intended for use in a wide temperature range.

Supports and dies can be set at an exact parallel. A lateral support bracket ensures exact maintenance in the center position.

Measurement surfaces on the inner sides of the supports allow for exact monitoring of the support span.

Various adjustment gauges and lead screw settings, as well as a height setting of the upper anvil are available for testing of varying specimen thicknesses.

Standard	Die Radius, R	Support Radius, r	Span, L	Centering Accuracy
ISO 14130	5 mm	2 mm	5 h ± 0,3 mm	-
ASTM D 2344	3 mm	1,5 mm	4 h ± 0,3 mm	± 0,3 mm
EN 2377	3 ... 5 mm	2 ... 3 mm	5 h ± 0,1 mm	-
EN 2563	3 mm	3 mm	5 h ± 0,1 mm	± 0,02 mm
CRAG method 100	3 mm	3 mm	4 h ± 0,5 mm	-
			5 h ± 0,5 mm	

h = specimen thickness

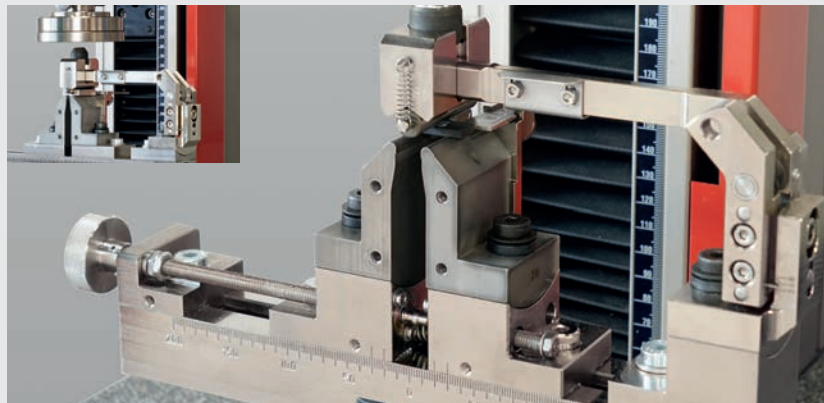

Fig. 2: ILSS fixture: A laterally guided upper anvil ensures exact central force application on the specimen. The support span is set manually or through centered lead screw adjustment.



Fig. 3: Standard 10 mm adjustment gauge for exact alignment



Fig. 1: Support and die are exactly parallel. Centering stops make operation easy.



Fig. 4: Adjustment gauge with variable support span



Fig. 5: Attachment of a temperature sensor close to the specimen

Flexure tests

Three-point and 4-point flexure tests are performed with support spans of 16 to 40 times the specimen thickness. This keeps the shear portion sufficiently low.

The measured flexure moduli and strengths are strongly influenced by the laminate structure and therefore do not correlate with the measured tensile properties.

Deflections are generally determined using a displacement transducer placed at the mid-span below the specimen.

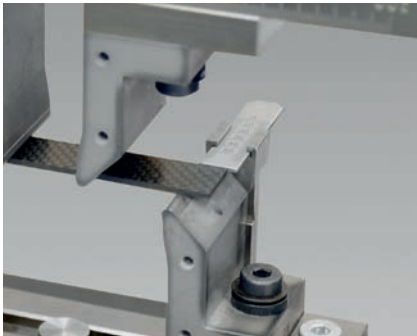

Fig. 1: Exact positioning of the specimen with the use of stops

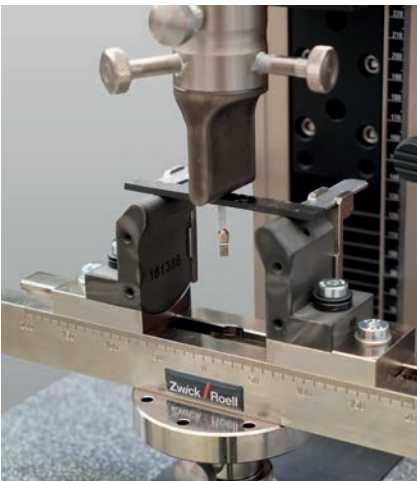

Fig. 2: 3-point flexure test with indirect displacement measurement via crosshead travel

Standard	Method	Specimen Thickness, h	Die Radius, R	Support Radius, r
ISO 14125	3-point	≤ 3 mm	5 mm	2 mm
		> 3mm	5 mm	5 mm
	4-point	≤ 3 mm	2 mm	2 mm
		> 3mm	5 mm	5 mm
ASTM D 7264			5 mm	5 mm
ASTM D 790	3-point	-	5 mm	5 mm
EN 2562	3-point	-	12,5 mm	5 mm
EN 2746	3-point	-	5 mm	2 mm

However, ZwickRoell testing machines are additionally equipped with a highly accurate deformation compensation system, which in the case of 3-point flexure tests often allows for a sufficiently accurate de-

flexion measurement with the integrated crosshead travel monitor.

The flexure test kits can be used over a wide temperature range, between -80 °C and +250 °C.



Fig. 3: Die and supports are clamped under load and aligned with the adjustment gauge.

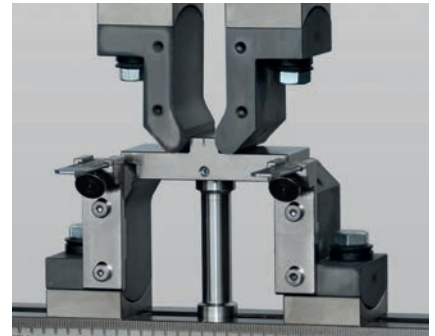

Fig. 5: Adjustment gauge for the 4-point flexure test arrangement

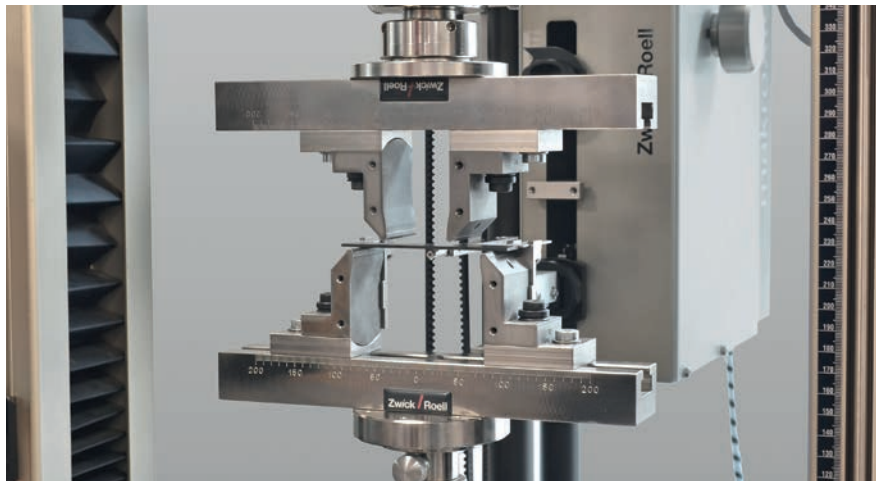

Fig. 4: 4-point flexure test with direct displacement measurement

Interlaminar energy release rate (G)

When measuring the critical energy release rate (G_c) the energy per crack area required to propagate a crack by a known path is determined.

Mode I — crack opening — is usually measured in a DCB (double cantilever beam) arrangement and is described in many standards.

Mode II — in-plane shear — is frequently measured by the ENF (end notch flexure) method, using a 3-point or, less commonly, 4-point flexure method. The ISO standard applies the C-ELS (calibrated end loaded split) method. Less common is the TCT (transverse crack tension) method.

The mixed mode I/II bending (MMB) method allows for the setting of defined mode proportions and simulates the superimposed loads, which occur frequently in practice.

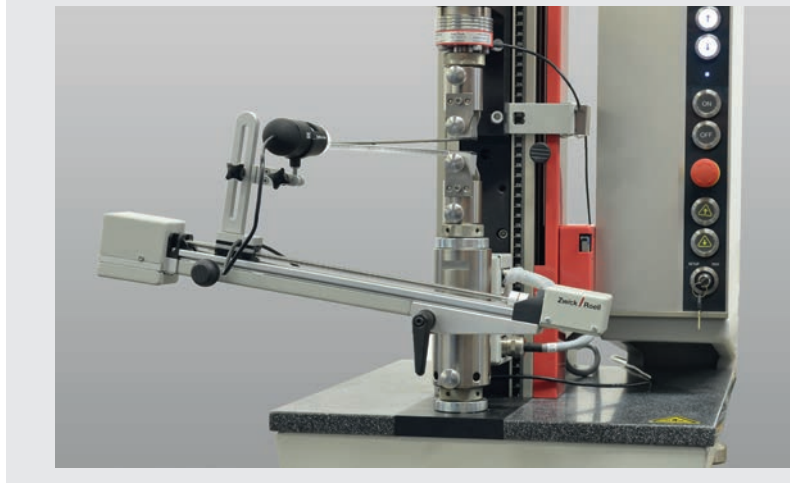
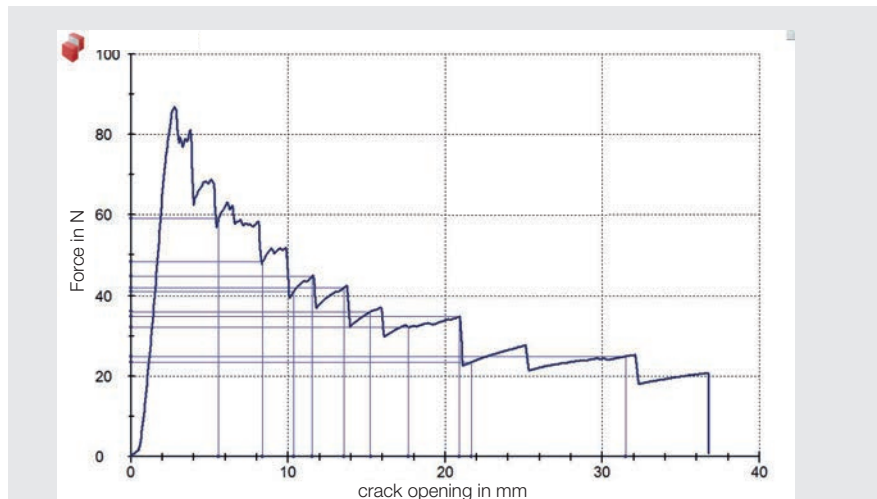

Fig. 2: Mode I energy release rate (G_{IC}) in a double cantilever beam (DCB) arrangement. Tracking of the crack tip with video recording delivers a film sequence synchronized with the force-displacement curve.



Fig. 1: Mode II energy release rate G_{IIc}



Fig. 3: Adjustable Mode I / Mode II proportions

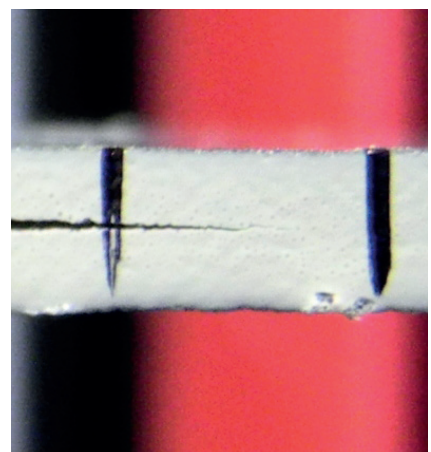

Fig. 4: The crack tip is followed with a magnifying glass.

Pin-bearing strength and bearing response

Evaluation of the load bearing capacity of pin or bolted joints is part of many standards and quality assurance instructions.

The choice of test arrangement is based on the anticipated loading situation. This can be designed with single lap or double lap shear configurations and refer to a single bolted joint or double screw connection with the corresponding bypass forces that occur.

Furthermore, the methods differ with regard to the type of connection, which may be a loose support with a known gap between the specimen and the holding platform, or as a screw connection with known tightening torque.

For measurement of the bearing response an extensometer is attached to the retaining plate and the specimen.

The tests are mostly performed in the tensile direction, and less often also as compression tests.

Ready-to-use testXpert III Standard Test Programs ensure exact standard compliance.

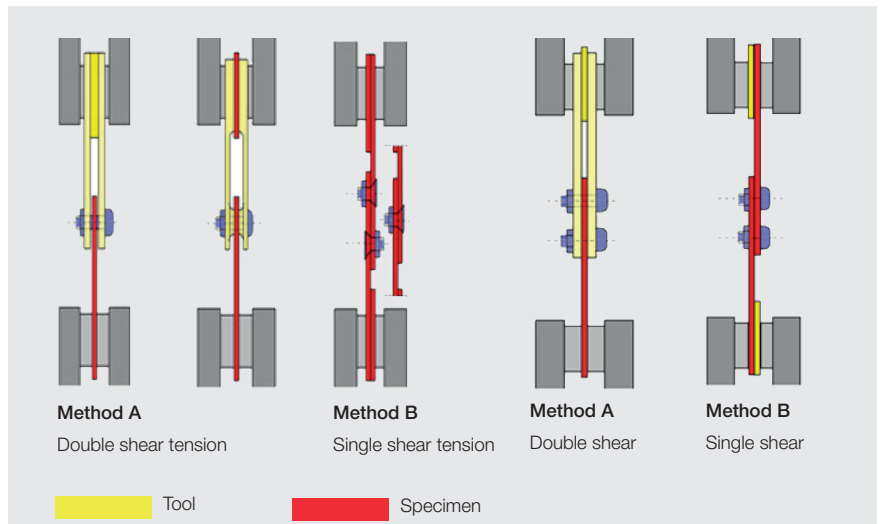

Fig. 1: Method for measurement of pin-bearing strength and bearing response with direct and bypass loading

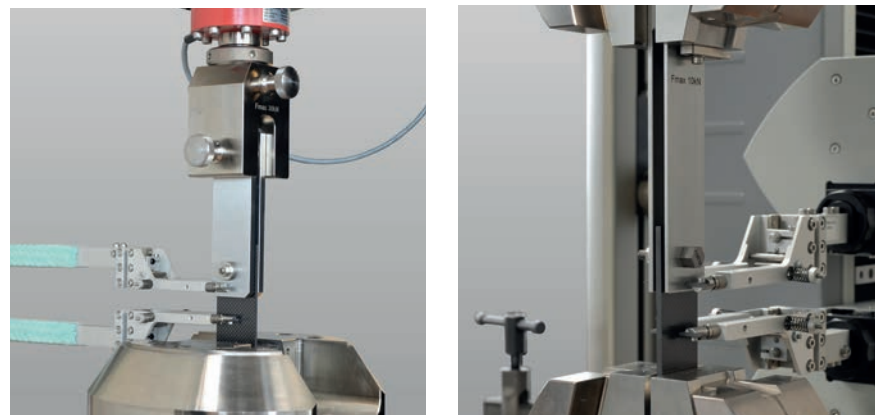

Fig. 2: Test tools for measurement of pin-bearing strength and bearing response

Electromechanical testing machines

zwickiLine

These high-quality, easy to operate single-column load frames were designed for mechanical tests with test loads up to 5 kN.

In composites testing laboratories they are often used as an auxiliary machine for larger load frames to avoid having to reconfigure the latter for tests such as flexure, shear and G_{IC} -, G_{IIC} - tests.

ProLine series for standard test tasks

Many standard types of tests involving tensile, compression, shear or peel loads do not require expensive sensor equipment. In such cases a ProLine testing machine may be the optimal choice.

Table-top models – AllroundLine

Various table-top models are available for standard tests in a force range up to 150 kN. They are equipped with two columns constructed of patented extruded aluminum profiles.

They are light, flexurally stiff and function as both lead screw guide and guard. The AllroundLine table-top models can be provided with support legs to enable the test area to be positioned at the optimum height for the operator or the application. This allows for the machine to be operated conveniently from a seated position with completely free leg space, making the system well suited for operation by wheelchair users.



Floor-standing models – AllroundLine

Floor-standing models with electro-mechanical drives are available in a load range from 100 kN to 1200 kN and are used for tests on material specimens or structural components. Test types include tensile, compression and flexure tests, shear tests and torsion tests.

Extremely stiff load frame construction with two or four guide columns ensures optimum conditions for accurate alignment of the test axes. The load frames can be equipped

with one or more test areas. Models with side test areas minimize the re-configuration efforts, since the tools for different test types stay in the machine.

For components testing the lower crosshead can be supplied as a mounting platform. For torsion tests the load frame is equipped with a torsion drive with testControl II and corresponding sensors. The AllroundLine floor-standing models therefore form a high-quality and flexible testing system for testing of composite materials.

testControl II – measurement and control electronics

testControl II is “Made by ZwickRoell” and optimally equipped for the requirements of composite materials testing. The measured values from the sensors are scanned at a rate of 400 kHz and then further processed at 2000 Hz. Combined with 24 bit signal resolution, this achieves optimal signal quality over the entire speed range.



High-capacity machines

The high laminate strength of fiber composites requires specimens that are adapted in regards to their dimensions. Very high forces are especially prominent in tensile, compression and CAI tests.

Electromechanical high-capacity machines of the Allround series with nominal loads between 300 kN and 1200 kN allow for testing with high, but also very low forces. The modular fixture arrangement makes it easy and convenient to switch tools for the various test types.

Temperature chambers that can be moved out allow for testing in a wide range of temperatures.

A safety housing with an electrically interlocked safety door ensures the safety of the operator.

Exact alignment of the load string is ensured with the use of an alignment fixture.



Fig. 1: High-capacity machine Z600

Temperature chambers

Temperature chambers that can be conveniently driven into the test area on a guide rail are used for testing at both low and high temperatures. ZwickRoell temperature chambers provide the highest level of integration with the testing system and therefore ensure safe and reliable operation.

- Best temperature accuracy and distribution
- Temperature measurement near specimen and exact control
- Easy insertion of the specimen with the innovative door-in-door technology
- Time savings through preconditioning of the specimen in an interim magazine
- Exact positioning of the specimen with mechanical insertion aids
- Optional side slots or panes with optical glass for the use of side mounted mechanical or non-contact extensometers
- Cable ducts for clip-on extensometers
- Front door with electrical interlocking and safety door function
- Full integration with testXpert III for temperature control, variable fan speed, recording of the temperature during the test and switching on the internal lighting.

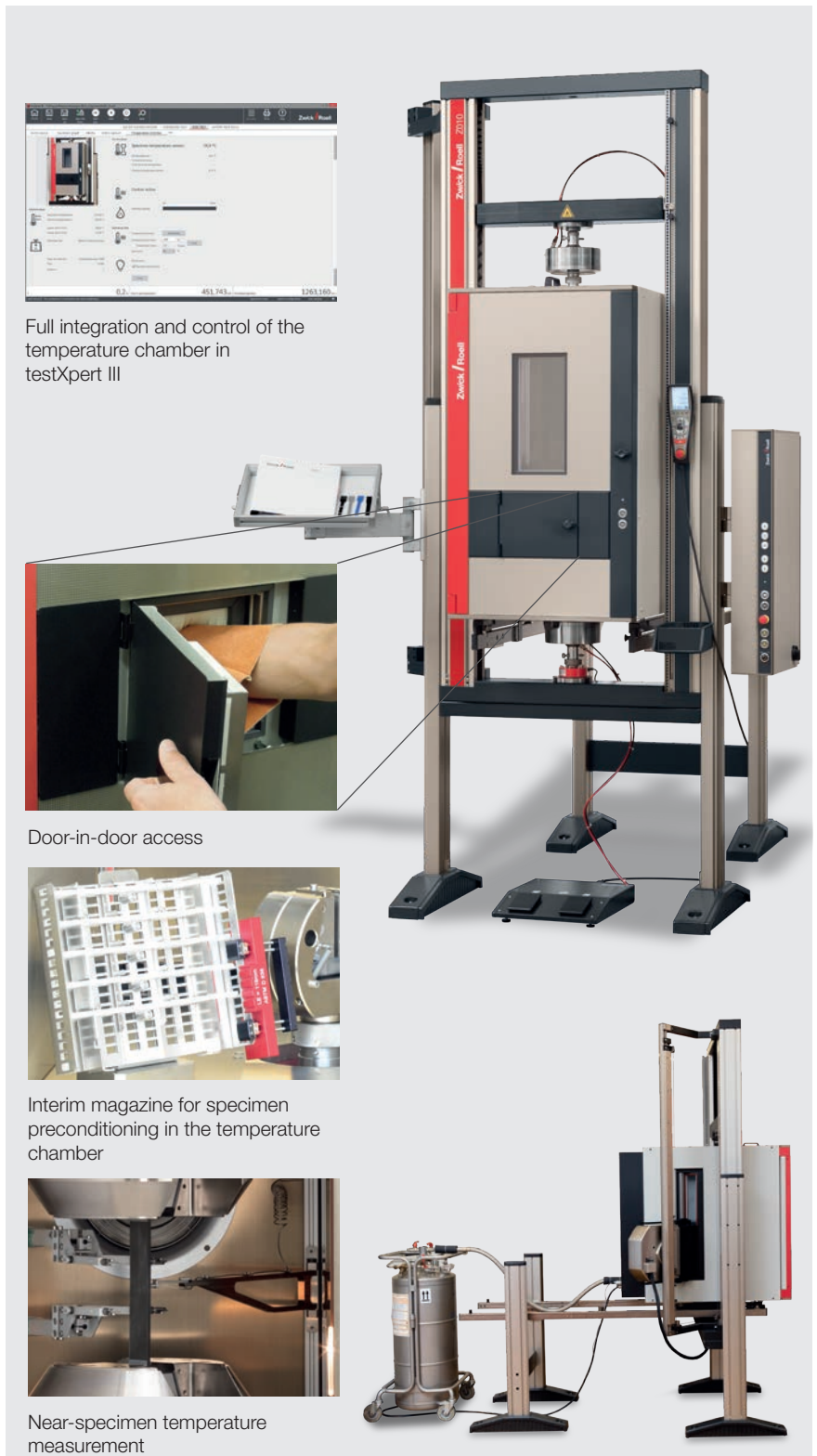

Fig. 1: The temperature chamber system is fully integrated in the testing machine. It provides a number of benefits that make the test safe and efficient.

A modular concept for testing in temperature chambers

In aerospace applications, composites are routinely subjected to outside air temperatures of $-55\text{ }^{\circ}\text{C}$, more than $+200\text{ }^{\circ}\text{C}$ in the area of the exhaust stream, and even higher temperatures in the engines.

To reproduce these conditions during testing, temperature conditioning devices are available, which can be moved into the test area of the load frame on guide rails. The tools for the different tests can be connected to the existing hydraulic grips via mechanical adapters.

Variable load frames

The available installation area is optimized at the lowest possible load frame height. Rigid flange connection with the specimen grips ensure good lateral stability, also allowing for compression tests at higher loads. Provision is made for optional installation of an alignment fixture to ensure exact straightening of the test axis for alignment-sensitive tests.

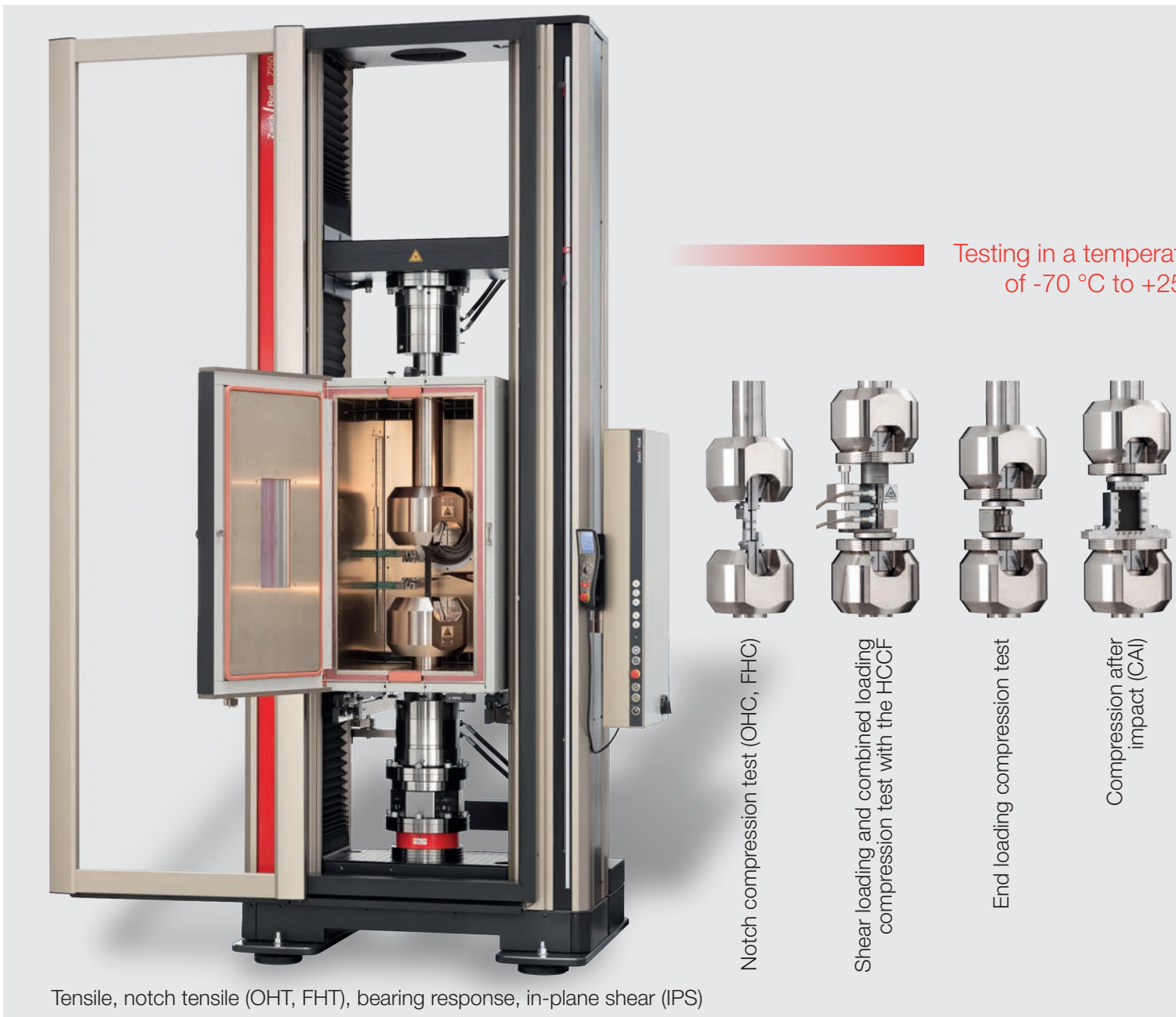

21 types of tests, 115 standards

The modular testing system covers all the important standard tests for fiber-reinforced composites:

- Tensile tests
- Notch tensile tests, OHT and FHT
- In-plane shear tests, IPS
- Interlaminar shear strength test, ILSS
- Compression tests, CAI compression tests

- Notched compression tests, OHC and FHC
- V-notch shear tests
- Bearing response tests

Additional tests at ambient temperature

Withdrawing the temperature chamber allows for additional tests requiring a smaller load cell:

- Three-point and four-point flexure tests
- Measurement of energy release rates G_{IC} and G_{IIC}

This modular system is available for electromechanical testing machines with load stages 100 kN, 250 kN and 600 kN, as well as for different servohydraulic testing machines for fatigue tests.

Temperature range
-50 °C

Testing at ambient temperature



Fatigue testing machines

For dynamic cyclic testing of composites, testing machines with different drive systems are used.

LTM testing machines with linear motor technology are manufactured in nominal load stages of 1 kN, 2 kN, 3 kN, 5 kN and 10 kN. The core piece is the patented electrodynamic drive specifically developed for testing technology. It allows for test frequencies up to 100 Hz and is able to exactly and reproducibly perform a wide variety of function sequences such as sinusoidal, triangular, rectangular and trapezoidal functions, as well as follow-up tests. The strongest feature of this drive is precise test performance at low operation and service costs. For operation of the LTM only a suitable power supply is required.

Servohydraulic testing machines are used for dynamic cyclic tests as well as static tests. The standard frequency range reaches up to 100 Hz, at forces up to 2500 kN. Common load frames are manufactured with nominal load stages of 10 kN, 25 kN, 100 kN, 250 kN and 500 kN. The hydraulic power is either supplied by a power pack on the testing machine, or from a central hydraulic system. The compact series machines use an integrated low-noise power pack and allow for space-optimized operation in laboratories without central hydraulics. Both types of machine are equipped with force and piston displacement transducers and can be expanded with additional sensors, temperature chambers and safety devices, as well as various cooling principles.



Fig. 1: LTM 10 - fatigue testing for various test types in the load range



Fig. 2: Servohydraulic testing machine type HB100 (left) and HC compact (right). Modular design for dynamic and static testing of composite materials.

Automation

Qualification of new composite systems requires a comprehensive testing campaign. ZwickRoell is a specialist for automation in testing technology and provides proven systems with exceptional features.

roboTest L—automation

This automated system operates with pneumatic vacuum grippers or claw grips. Up to 450 specimens are placed on a table in stacks or magazine compartments. The specimen cross-section can be measured during the automated sequence, and an integrated barcode reader system is available for specimen identification.

roboTest R—automation

This automated system is very useful if several testing machines are

integrated into a system, for applications in a temperature conditioning device and for tests that require special specimen handling.

Advantages:

- Reliable test results:
 - Accurate**—because all sensors are precisely calibrated
 - Repeatable**—because automation ensures that all processes are carried out exactly the same way
 - Reproducible**—because the test sequences follow standard requirements accurately, without deviations among operators
 - Traceable**—because everything is logged in detail
- Expanded capacity through unmanned testing overnight or on weekends
- Sorting of specimen remains
- Documentation of failure types



Fig. 2: roboTest L automation



Fig. 3: roboTest R automation



Fig. 1: Fully automated testing system with two load frames for tensile, OHT, FHT, IPS, lap shear, ILSS, bearing response and flexure tests over a wide temperature range

Drop weight testers

The main area of application for drop weight testers in fiber composites testing is pre-damaging of test specimens for the compression after impact (CAI) test, for example to ISO 18352, Airbus AITM 1.0010, Boeing BSS 7260, ASTM D7136, EN 6038 or DIN 65561.

ZwickRoell offers three drop weight tester types with different application emphasis:

HIT 230 F

Instrumented drop weight tester for CAI and puncture tests up to 4.43 m/s and a potential energy up to 230 J

HIT 600 F

Instrumented drop weight tester with acceleration unit for CAI and puncture tests up to 8 m/s and a potential energy up to 600 J

HIT 1100F and HIT 2000F

Universal drop weight testers for

instrumented standard and components testing up to 19 m/s and 2000 J

Key features:

- Easy and reliable operation
- Easy accessibility
- Variable damage energy setting
- Accurate measurement of damage progression with integrated instrumentation
- Reliable prevention of multiple impacts
- Monitoring of the actual impact speed

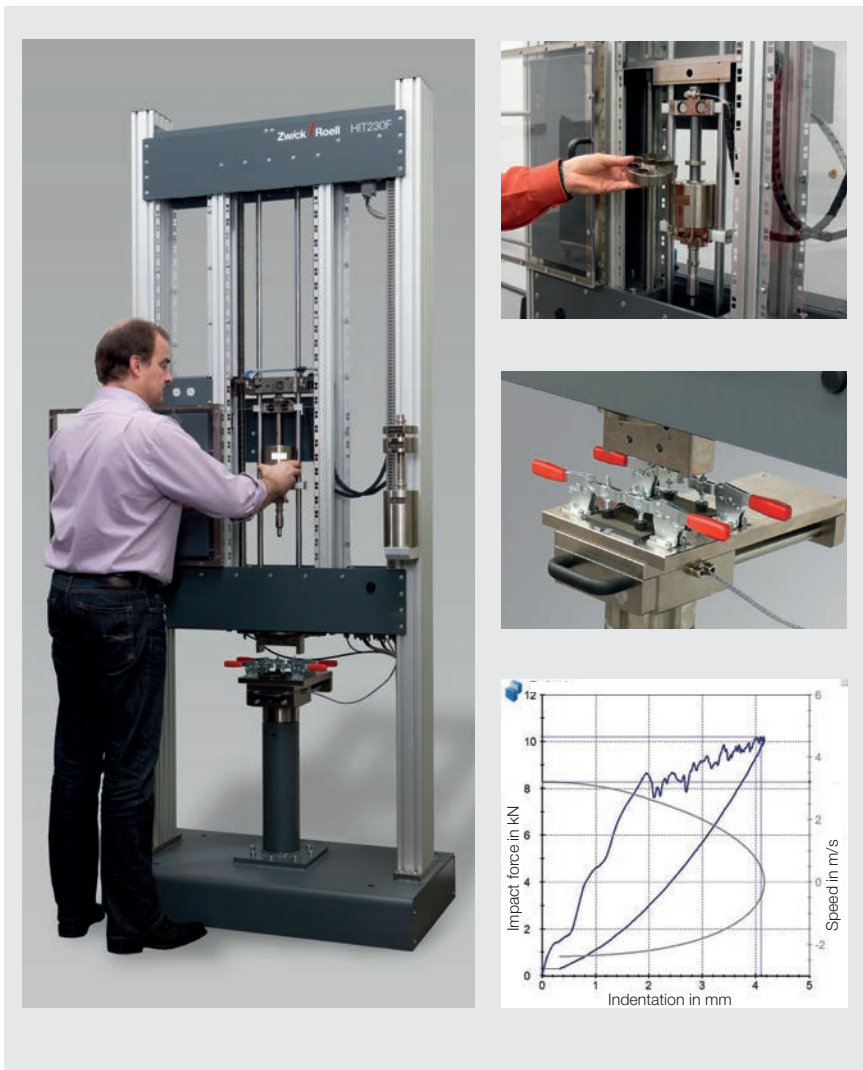

Fig. 1: The instrumented HIT 230F drop weight tester is used for pre-damaging of test panels for CAI testing. The force travel diagram shows the damage progression.

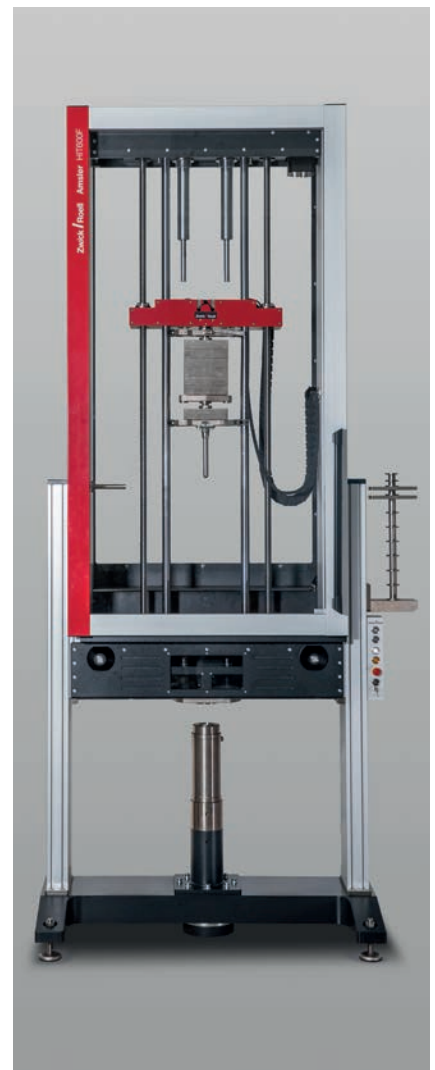

Fig. 2: Drop weight tester Amsler HIT600F

Load cells

Load cells must satisfy the highest quality requirements.

The basis for this is a calibration to ISO 7500-1 or ASTM E4. This calibration is performed as a factory calibration, and can be repeated by our service technicians as a DAKKS, COFRAC or NAMAS calibration after the testing equipment has been commissioned. This way you can always rely on your testing machine.

But ZwickRoell load cells can do much more:

Automatic identification with integrated zero-point and sensitivity adjustment ensure that any load cell can be used with any testing machine without the need for a new calibration.

Temperature compensation makes measuring largely independent of the actual ambient temperature.



Fig. 2: Every load cell undergoes a ZwickRoell factory calibration as soon as it enters service on a testing machine.

This all takes place over a very wide measuring range in which measurements are performed to accuracy class 0.5 or 1.

Xforce HP and Xforce K series load cells reach accuracy class 1, starting at 0.1% of the nominal load.



Fig. 1: Load cells for the most demanding quality requirements. Installed Xforce HP series load cell (left). Various Xforce HP and P series load cells (right).



Fig. 1: Workflow based on the user's lab processes from an administrator view with full functionality - www.testXpert.com

testXpert III testing software

Intuitive and workflow-based from the very start.

testXpert III is the result of close cooperation with software users in the materials testing industry and the experience of over 35,000 successful testXpert installations. From the very start, users can easily and intuitively navigate testXpert III. Meaningful icons and clear visual connections help the user, and reduce the number of mouse clicks required.

A workflow aligned to your operating processes

The software guides you through the various stages of a test, from preparing and running the test to analyzing results.

- Set up testing system—configure all machine-related settings for your testing application.
- Configure test—set all test-related parameters, such as selecting results with the intelligent wizard.
- Run test—experience fast and easy navigation through the entire test sequence.
- View results—verify all test data, also in secure mode.

Intelligent user management means you can define different user roles or adopt user roles defined in the Windows accounts with LDAP. The user can focus on the task at hand right from the start and avoid input errors. testXpert III is workflow-based throughout, keeping training time to a minimum and enabling efficient, reliable testing.

System Configuration Builder — a unique software concept

System Configuration Builder allows you to preset and save all relevant testing system and safety settings such as crosshead position, distance between fixtures, or sensor

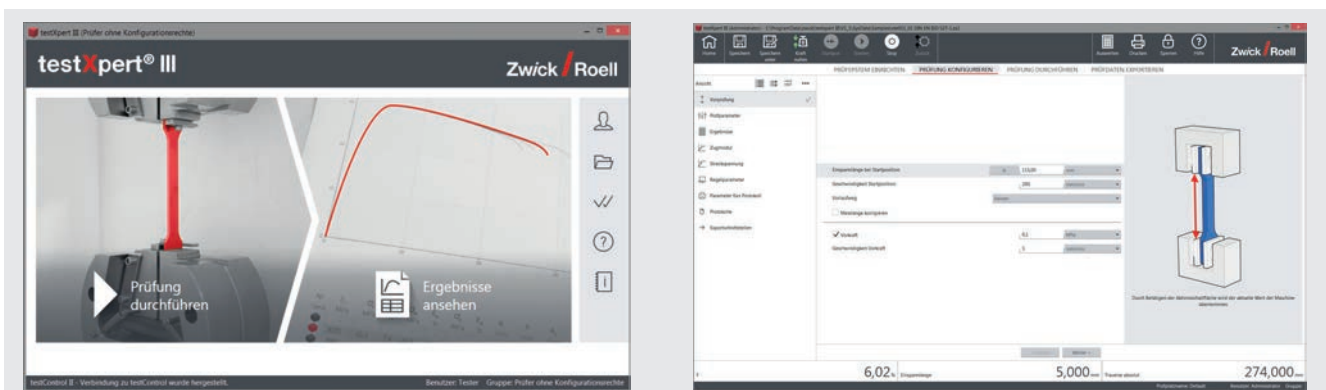

Fig. 2: View optimized for the tester (left); the intelligent wizard for test configuration (right)

configuration in a freely definable system configuration. The saved system configuration checks the connected sensors. The test can only be started when the parameters match the preset requirements. This ensures exactly reproducible test conditions.

Tamper-proof test results

testXpert III logs all testing system and system settings, ensuring traceable results. The traceability offered by testXpert III means you always have answers to the question: "When does who do what, why and who is responsible?"

testXpert III guarantees reliable test results and maximum security for users and the testing system.

Reliable import and export

testXpert III can communicate directly with any IT system. All test-related data is imported quickly and directly from ERP systems, databases or directly from external devices. Data can easily be exported to all your usual evaluation/analysis platforms.

Standard-compliant testing

testXpert III offers over 600 prepared Standard Test Programs, preconfigured to test standard requirements and with integrated results tables and statistics. You can begin standard-compliant testing immediately. testXpert III will take care of the rest.

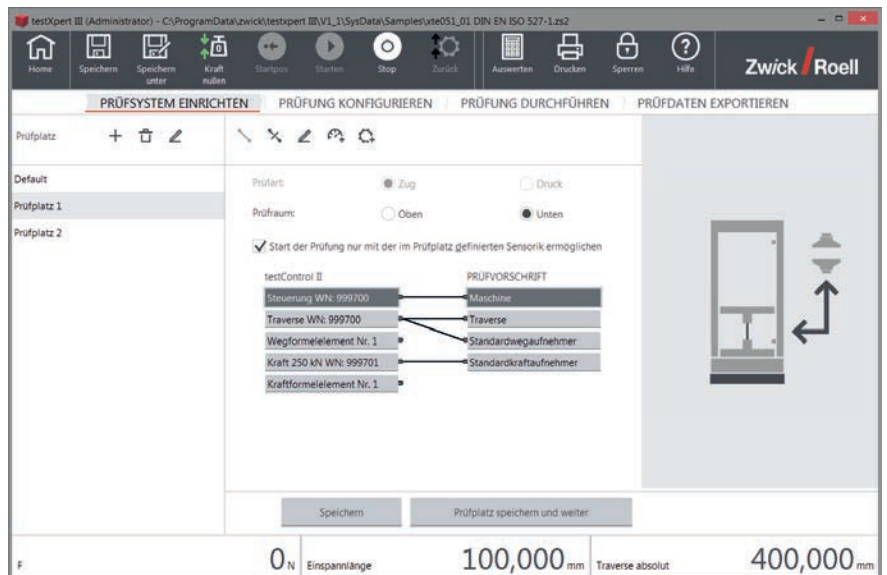

Fig. 1: This means that saved test environments can be recreated following a change of test arrangement, so that tests can be performed using identical settings.

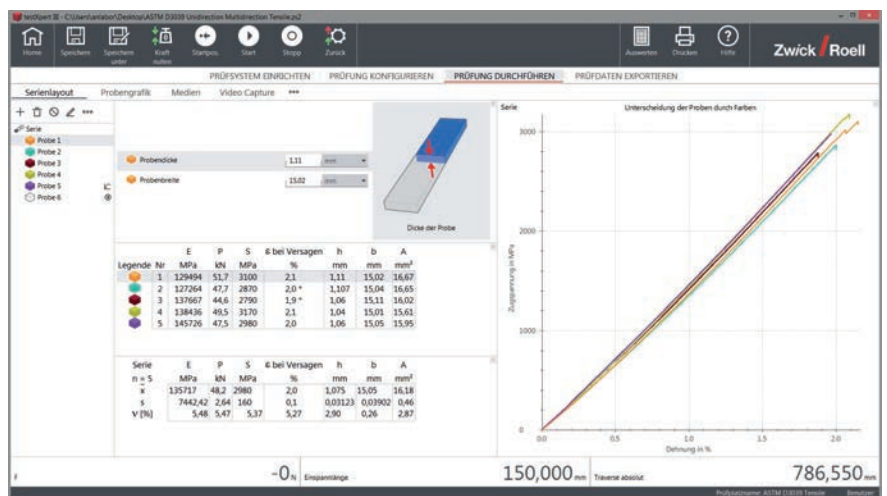

Fig. 2: Structured workflow with clear visual association of related content

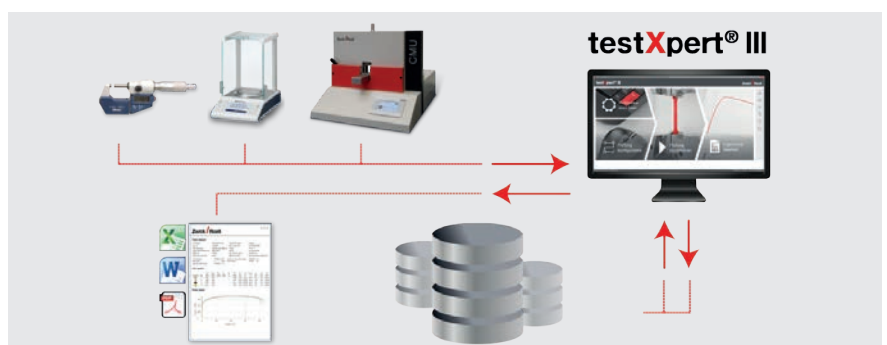

Fig. 3: Reliable and simple interfaces for sharing the test results

Precise strain and extension measurement

Strain gauges are still widely used in the field of fiber-reinforced composites. They can be attached directly to the specimen or act as the measuring element in a clip-on extensometer.

The measurement signals are acquired precisely, directly and synchronously by ZwickRoell's testControl II measurement electronics.

Alternatively, measurement amplifiers by HBM, e.g. the MGC or QuantumX are available, which are fully integrated in the ZwickRoell environment in testXpert III.

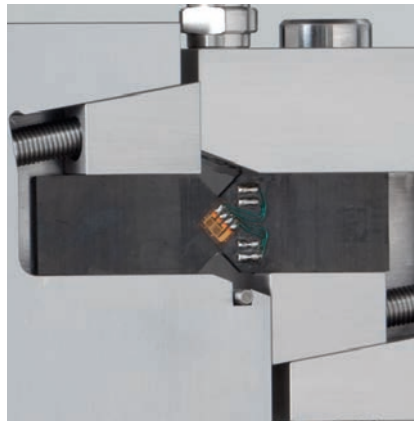

Fig. 2: Strain gauges are applied directly to the specimen.



Fig. 5: Clip-on axial extensometer

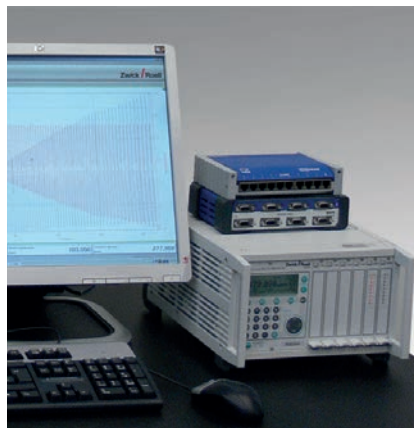

Fig. 3: HBM measurement amplifiers are supported by testXpert III.

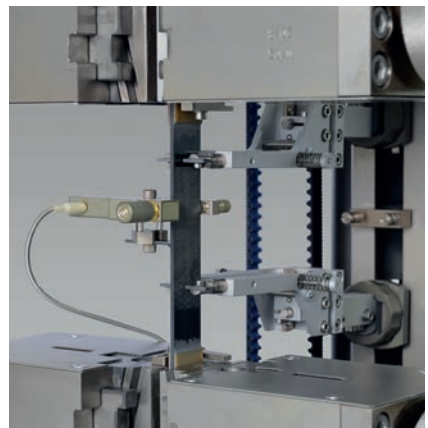

Fig. 6: Clip-on transverse strain extensometer

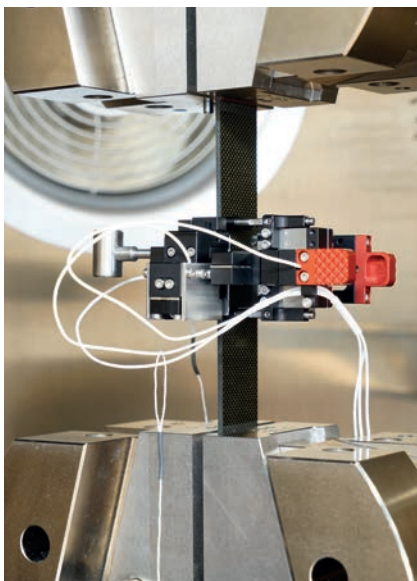

Fig. 1: The biaxial clip-on extensometer can be used at both high and low temperatures.



Fig. 4: Direct connection of the strain gauges to testControl II via a ready-configured control box.



Fig. 1: Mechanical measurement, automatic attachment: makroXtens



Fig. 2: makroXtens with long feeler sensors for tensile testing in a temperature chamber



Fig. 4: makroXtens with transverse strain extensometer for tensile or in-plane shear (IPS) tests at RT

Automatic extension measurement with makroXtens

Automatic extensometers using a mechanical or optical measuring principle simplify test preparation and performance.

The makroXtens employs mechanical measurement and is used for many types of tests. With a high measurement value resolution of up to $0.006 \mu\text{m}$ it satisfies the additional requirements for modulus measurement in tensile tests to ISO 527-1. Its swiveling knife edges provide reliable protection up to specimen break.



Fig. 3: makroXtens with flexure sensors for 3- and 4-point flexure tests



Fig. 5: makroXtens for module determination in an end loading compression test

Non-contact extension measurement with videoXtens

ZwickRoell is a leader in non-contact measurement. While the videoXtens HP tracks the displacement of gauge marks via image analysis, the natural pattern on the specimen surface is enough for the videoXtens biax HP for opaque fiber-reinforced composites, to determine longitudinal and transverse strain without the need for additional markings.

The videoXtens HP and the videoXtens biax HP are ideal for tensile, in-plane shear (IPS) and flexure tests and can be used at ambient temperature, as well as the

entire temperature range of the temperature chamber.

Both instruments meet the strict requirements on strain measurement for determination of the Young's modulus to ISO 527-1 Annex C.

With an additional camera for transverse strain measurement, material characteristics such as Poisson's ratio and shear modulus can be determined with very high accuracy, using the videoXtens biax HP.

Through non-contact measurement the possibility of damage to the videoXtens, even at very high energy failure modes, is eliminated. The strain measurement can therefore be carried out until specimen break.

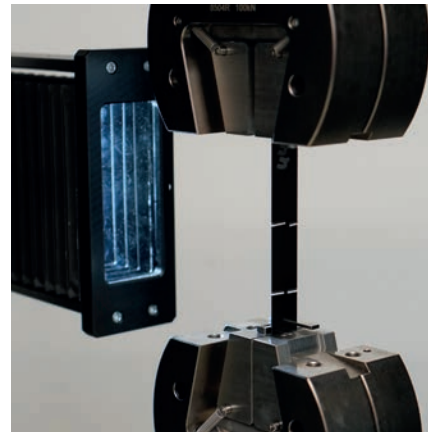

Fig. 3: Non-contact strain measurement with videoXtens HP using gauge marks

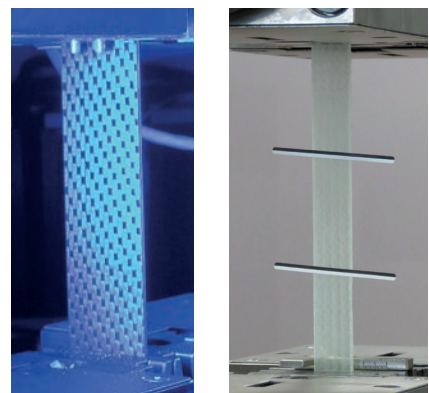
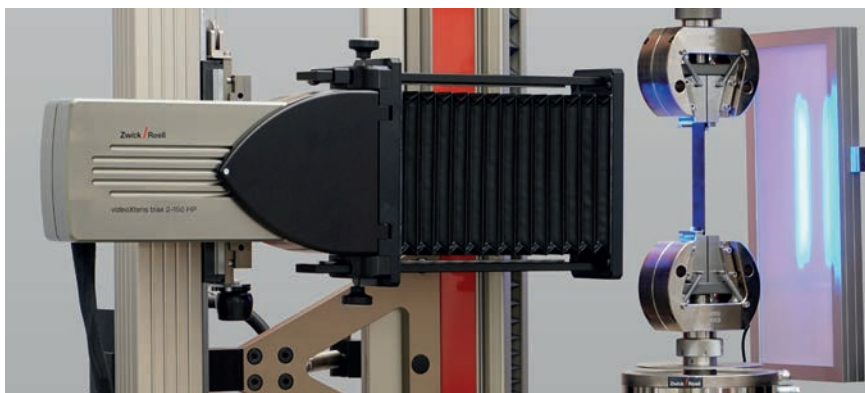

Fig. 1: Non-contact strain measurement with videoXtens biax HP (left) using the natural pattern of the specimen surface (center) or with the use of gauge marks (right)

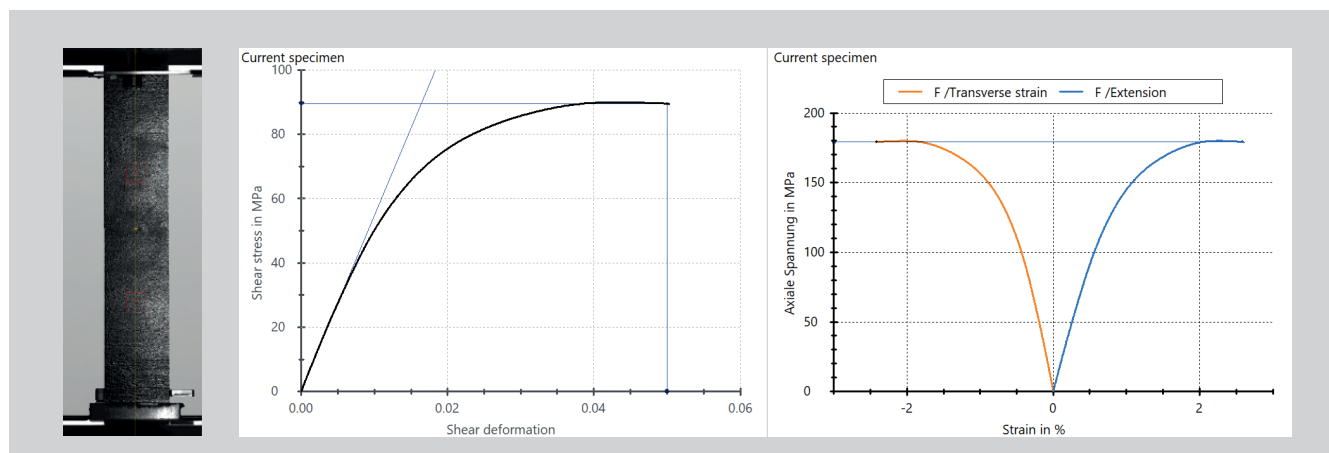

Fig. 2: Strain measurement without the use of gauge marks using the videoXtens HP in an in-plane shear (IPS) test. Natural surface pattern of the unidirectional CFRP material IPS specimen (left), shear stress/shear strain curve (center), determined longitudinal and transverse strain (right).

Exact alignment of the testing machine

Testing machine alignment errors lead to the introduction of non-axial specimen deformations. Especially in the case of unidirectional reinforced composite materials this can have significant influence on the test results.

ZwickRoell testing machines are precision manufactured, with guide components that satisfy the strictest quality requirements.

Exact axial alignment of specimen grips for alignment-sensitive fiber-reinforced composites, and elimination of angular errors is achieved by accurate adjustment performed by means of an alignment fixture.

The result of these adjustments is checked with a precision alignment gauge, which satisfies the require-

Alignment errors lead to elevated outer fiber strain and therefore to apparently lower resistance through premature specimen failure.

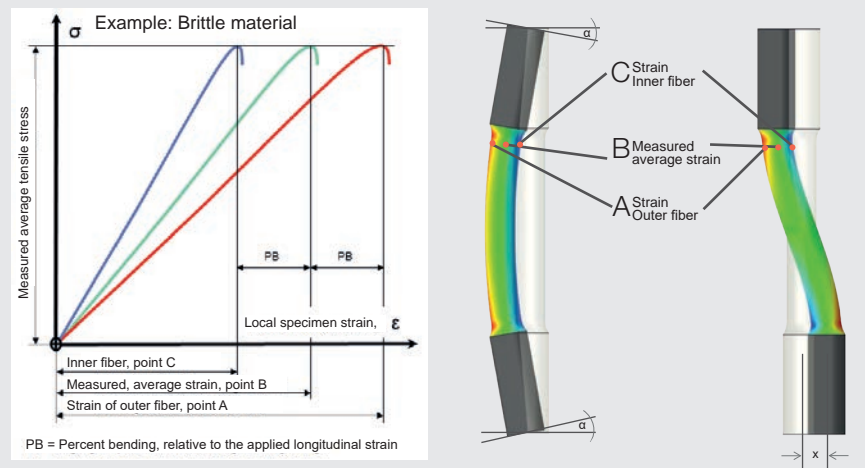

Fig. 2: Typical alignment errors: angle error (left), concentric offset error (right)

ments of ASTM E1012, ISO 23788, and for the aerospace industry the Nadcap Audit Criteria AC7122.

ZwickRoell supplies the necessary

adjustment and measurement equipment, as well as alignment measurement as a service provided by experienced and well trained service technicians.



Fig. 1: Testing machine alignment and verification by a ZwickRoell technician using alignment in accordance with Nadcap AC 7122

Services

Laboratory for Materials and Components Testing

For companies with a testing requirement but no suitable testing option, ZwickRoell's Laboratory for Materials and Components Testing is ready to provide expert assistance.

We can also help out in the event of capacity bottlenecks or perform cross-validation tests. It makes no difference whether just a single test is involved or entire test series. With the latest technology and modern testing machines, we guarantee fast, standard-compliant testing. Naturally we can also perform tests in accordance with factory standards.

Our Laboratories for Materials and Components Testing perform testing services of all kinds, on all static and dynamic materials testing machines. Hardness and extrusion tests, and torsion and temperature tests can be performed as well.

Our testing is individually tailored for a wide range of components and materials, whether metals, plastics, composites, rubber, or other — you're in good hands with us.

Contact:
Tel. +49 7305 10-11440
contract-testing@zwickroell.com



Fig. 1: Static testing machines and instruments in the ZwickRoell testing laboratory



Fig. 2: An excerpt of the dynamic testing machines in the ZwickRoell Materials and Components Testing Laboratory



Fig. 3: Materials and Components Testing Laboratory

Application technology

Our technical field consultants and experienced application engineers are here to provide you with expert consultation. Our qualified engineers will draw on their solid expertise to provide support during the planning and implementation of all or any testing applications.

Our Applications Testing Laboratories are equipped with permanent materials testing machine displays and instruments, including a comprehensive portfolio of accessories such as specimen grips, test fixtures, sensors, and temperature chambers.

Overview of services

Our service technicians guarantee successful and easy commissioning — from installation to initial calibration to any training instructions.

Customer support

The ZwickRoell Hotline is always available to support customers with questions regarding troubleshooting hardware and software.

Inspection and calibration

Naturally, we will also carry out the required annual inspection and calibration. Our checklist-based inspections and calibrations provide a sound basis for reliable test results. They also extend the life of your materials testing machines and instruments, saving operating costs in the long term.



Fig. 1: Experienced application engineers will advise you on individually tailored testing options



Fig. 2: ZwickRoell operates a DAkkS-accredited calibration laboratory. With over 10,000 calibrations performed annually, this is the largest calibration laboratory in Germany.

Software services

Once you have purchased your testing software we are ready to provide additional software services upon your request — software trials, updates, customizations, training — whatever you need.

Training Courses at ZwickRoell Academy

Our ZwickRoell Academy offers a comprehensive, modular training program at ZwickRoell's headquarters in Ulm, at a ZwickRoell location near you, or directly on-site at your premises. This ranges from courses on our testing software, to applications courses and workshops, to courses tailored to your company's individual requirements.

Other services

If you need to move your materials testing machine to a different location, ZwickRoell's removal and relocation service will assist with technical and organizational planning, as well as transport and



Fig. 2: The ZwickRoell Academy offers an interesting and wide-ranging training program for new students and advanced users alike.

full recommissioning. Professional and documented verification of the alignment of your testing machine using standardized alignment transducers (referred to as alignment measurement) is a fundamental component of our service portfolio.

Furthermore, we are able to perform logged measuring system analyses on testing machines and determine the corresponding characteristic capability values.



Fig. 1: ZwickRoell provides continuous support throughout the entire life-cycle of materials testing systems.

Contents	Standards	Test fixture
Test fixtures and corresponding calibration		
Tensile, compression and flexure testing machines	DIN 51220, Airbus QVA-Z11-01-00, Airbus QVA-Z11-01-03	
Impact testing machines	ISO 13802, EN 10045-2, DIN 51230	
Force calibration	ISO 7500-1, -2, ASTM E4	
Extensometer calibration	ISO 9513, ISO 5893, ASTM E83	
Alignment	ASTM E1012, ISO 23788, Nadcap AC 7122/Annex A	
Environmental conditions, conditioning		
Humidity, moisture absorption	ASTM D5229, EN 2489, EN 2823	
Influence of test fluids	EN 2489	
Test temperatures	EN 2744	
Conditioning	EN 2743, EN 2823, SACMA SRM 11	
Production of specimens		
Production of test plates	ISO 1268, ISO 9353, EN 2374, EN 2565, EN 12576, DIN 65071	
Mechanical processing	ISO 2818	
Application of strain gauges	ASTM E1237	
Long-fiber-reinforced composites		
Testing of composite materials overview	ASTM D4762, ISO 20144, ASTM D6856	
Composite materials terminology	ASTM D3878	
Tensile testing of textile glass	ISO 3341, ISO 3342, ISO 3375	Materials testing machine
Tensile tests on single filaments and threads	ISO 11566, ISO 10618	Materials testing machine
Tensile tests on filament strands	ASTM D4018, ISO 9163	Materials testing machine
Tensile tests on pultruded rods	ASTM D3916	Materials testing machine
Tensile tests on hoop wound cylinders	ASTM D5450	Materials testing machine
Tensile tests on prepregs	DIN 65469, DIN 29971	Materials testing machine
Tensile tests on laminates	ISO 527-1, -4, -5, ASTM D3039, ASTM D7565, ASTM D3552, EN 2561, EN 2597, DIN 65378, AITM 1-0007, Airbus QVA-Z10-46-34, Airbus QVA-Z10-46-36, AITM 1-0049, Boeing BSS 7320, SACMA SRM 4R-94, SACMA SRM 9-94, TR 88012 CRAG Methods 300-303	Materials testing machine
Tensile tests on quilted connections	AITM 1-0029	Materials testing machine
Properties in thickness orientation	ISO 20975-1, -2, ASTM D7291	Materials testing machine
Shear tests on laminates	ASTM D7291	Materials testing machine
Notch tensile tests, OHT, FHT	ASTM D5766, ASTM 6742, AITM 1.0007, EN 6035, AITM 1-0050, SACMA SRM 5-94, NASA RP 1092 ST-3	Materials testing machine
Determination of the Poisson's ratio	ASTM E132, ISO 527-4, -5	Materials testing machine
Compression tests on pultruded rods	ISO 3597-3	Materials testing machine
Compression tests on hoop wound cylinders	ASTM D5449	Materials testing machine
Compression test, sandwich beam	ASTM D5467	Materials testing machine
Compression tests, end loading	ISO 14126 Method 2, ASTM D695, prEN 2850 B, DIN 65375, JIS K7076, Boeing BSS 7260 - type III and IV, SACMA SRM 1R-94, SACMA SRM 6-94, RAE-TR 88012 CRAG Methods 400 and 401	Materials testing machine
Compression tests, shear loading	ISO 14126 Method 1, ASTM D3410, prEN 2850 A, JIS K7076, AITM 1-0008, Airbus QVA-Z10-46-38, RAE-TR 88012 CRAG Methods 400 and 401	Materials testing machine
Compression tests, combined loading	ISO 14126 Method 2, ASTM D6641, ASTM C1358, AITM 1-0008	Materials testing machine
Notch compression tests, OHC, FHC	ISO 12817, ASTM D6484, ASTM D6742, prEN 6036, AITM 1-0008, Boeing BSS 7260 - Type 1, SACMA SRM 3R-94, NASA RP 1092 ST-4, RAE-TR 88012 CRAG Method 402, Northrop NAI-1504C	Materials testing machine
Compression residual strength after indentation	ASTM D6264	Materials testing machine
Damage tolerance, CAI compression after impact	ISO 18352, ASTM D7136, ASTM D7137, prEN 6038, AITM 1.0010, Boeing BSS 7260 - type II, CRAG Method 403, SACMA SRM 2R-94, DIN 65561, NASA RP 1092 ST-1	Drop weight tester & materials testing machine

Contents	Standards	Test fixture
Tensile residual strength and compression residual strength after edge impact	AITM 1-0076	Drop weight tester & materials testing machine
Flexure tests on laminates	ISO 14125, ASTM D790, ASTM D7264, EN 2562, EN 2746, TR 88012 CRAG Method 200, HSR/EPM-D-003-93	Materials testing machine
Flexure tests on pultruded profiles and rods	ISO 3597-2, ASTM D4476, EN 13706-2	Materials testing machine
Flexure tests on curved sections	ASTM D6415, AITM 1-0069	Materials testing machine
Short beam shear test, ILSS	ISO 14130, ASTM D2344, EN 2377, EN 2563, JIS K7078, Airbus QVA-Z10-46-10, AITM 1-0047, SACMA SRM 8-88, CRAG Method 100	Materials testing machine
Short beam shear test – double beam method	ISO 19927	Materials testing machine
Short beam shear test on pultruded rods	ISO 3597-4, ASTM D4475,	Materials testing machine
In-plane shear with $\pm 45^\circ$ tensile test, IPS	ISO 14129, ASTM D3518, EN 6031, DIN 65466, JIS K7079, AITM 1-0002, Airbus QVA-Z10-46-22, SACMA SRM 7-94, RAE TR 88012 CRAG Method 101	Materials testing machine
In-plane shear (IPS)	ISO 15310	Materials testing machine
In-plane shear, hoop wound cylinder	ASTM D5448	Materials testing machine
Lap shear	ASTM D3846, ASTM D3914, ASTM D7616, ASTM D5868, EN 2243-1, EN 2243-6, EN 6060, DIN 65148, AITM 1.0019, Airbus QVA-Z10-46-09, Airbus QVA-Z10-46-01, CRAG Method 102	Materials testing machine
Rail shear	ASTM D4255	Materials testing machine
V-notch shear	ASTM D5379, ASTM D7078	Materials testing machine
In-plane shear, shear frame method	ISO 20337, DIN EN ISO 20337	Materials testing machine
Bearing response, fastener connections	ISO 12815, ASTM D5961, ASTM D7248, EN 6037, DIN 65562, AITM 1-0009, AITM 1-0051, AITM 1-0065, AITM1-0067, TR 88012 CRAG Method 700, SACMA SRM 9-89	Materials testing machine
Fastener pull-through resistance	ASTM D7332, AITM 1-0066	Materials testing machine
Bearing response, pultruded profiles	EN 13706-2	Materials testing machine
Energy release rates G_{IC} (DCB)	ISO 15024, ASTM D5528, EN 6033, AITM 1-0005, AITM 1-0053, Boeing BSS 7273, Boeing BMS 8-276, ESIS TC 4, NASA Method RP 1092 ST-5	Materials testing machine
Energy release rates G_{IIC} (ENF)	ASTM D7905, prEN 6034, AITM 1-0006,	Materials testing machine
Energy release rates G_{IIC} (C-ELS)	ISO 15114, AITM 1-0068	Materials testing machine
Energy release rates, Mixed mode G_I/G_{II}	ASTM D6671	Materials testing machine
Long life fatigue of laminates	ISO 13003, ASTM D3479, AITM 1-0075, HSR/EPM-D-002-93	Servohydr. testing machine, LTM
Notch long life fatigue	ASTM D7615	Servohydr. testing machine, LTM
Long life fatigue of fastener connections	ASTM D6873, AITM 1-0074	Servohydr. testing machine, LTM
Mode I Fatigue delamination growth	ASTM D6115	Servohydr. testing machine, LTM
Hardness testing	ASTM D2583, EN 59	Barcol hardness tester
Heat deflection temperature HDT	ISO 75-1, -3, ASTM D648	HDT testing instrument
Creep tests	ASTM D7737	Creep testing machine
Impact strength, Izod	ASTM D256, ISO 180	Pendulum impact tester
Impact strength, Charpy	ISO 179-1, -2	Pendulum impact tester
Sandwich, core and honeycomb type composites		
Tensile test perpendicular to the faces	ASTM C297, ASTM D1623, EN 2243-4, DIN 53292, AITM 1-0025	Materials testing machine
Poisson's ratio of honeycomb core materials	ASTM D6790	Materials testing machine
Node tensile strength of honeycomb cores	ASTM C363, AITM 1-0061, Airbus QV-Z10-46-45	Materials testing machine
Transverse contraction of honeycomb cores	AITM 1-0062, Airbus QVA-Z10-46-46	Materials testing machine
Compression test perpendicular to the faces	ASTM C365, ISO 844, DIN 53291	Materials testing machine
Compressive strength and modulus of fillers	Airbus QVA-Z10-46-17	Materials testing machine

Energy absorption of honeycomb sandwich core materials	ASTM D7336	Materials testing machine
Compression after impact, CAI on surfacing	AITM 1-0077	Materials testing machine
Contents	Standards	Test fixture
Flexure tests	ASTM C393, ASTM D6416, ASTM D7249, ASTM D7956, DIN 53293, AITM 1-0018; Airbus QVA-Z10-46-31	Materials testing machine
Shear tests	ASTM 273, ASTM D8067, DIN 53294, AITM 1-0030, AITM 1-0046, AITM 1-0056, Airbus QVA-Z10-46-06	Materials testing machine
Flexural and shear stiffness test	ASTM D7250	
Climbing drum peel test	ASTM D1781, DIN 53295, AITM 1-0080, Airbus QVA-Z10-46-05	Materials testing machine
Ciba peel test	Airbus QVA-Z10-46-02	Materials testing machine
90° peel test (T-Peel)	ASTM D1876	Materials testing machine
Floating roller peel (Bell)	ASTM D3167, ISO 4578, Airbus QVA-Z10-46-03	Materials testing machine
Flexural creep test	ASTM D480	Creep testing machine
Shear fatigue behavior	ASTM C394	Servohydr. testing machine, LTM
Damage resistance	ASTM D7766, AITM 1-0057	Drop weight tester

Zwick / Roell

ZwickRoell

August-Nagel-Str. 11

D-89079 Ulm

Phone +49 7305 10 - 0

Fax +49 7305 10 - 11200

info@zwickroell.com

www.zwickroell.com

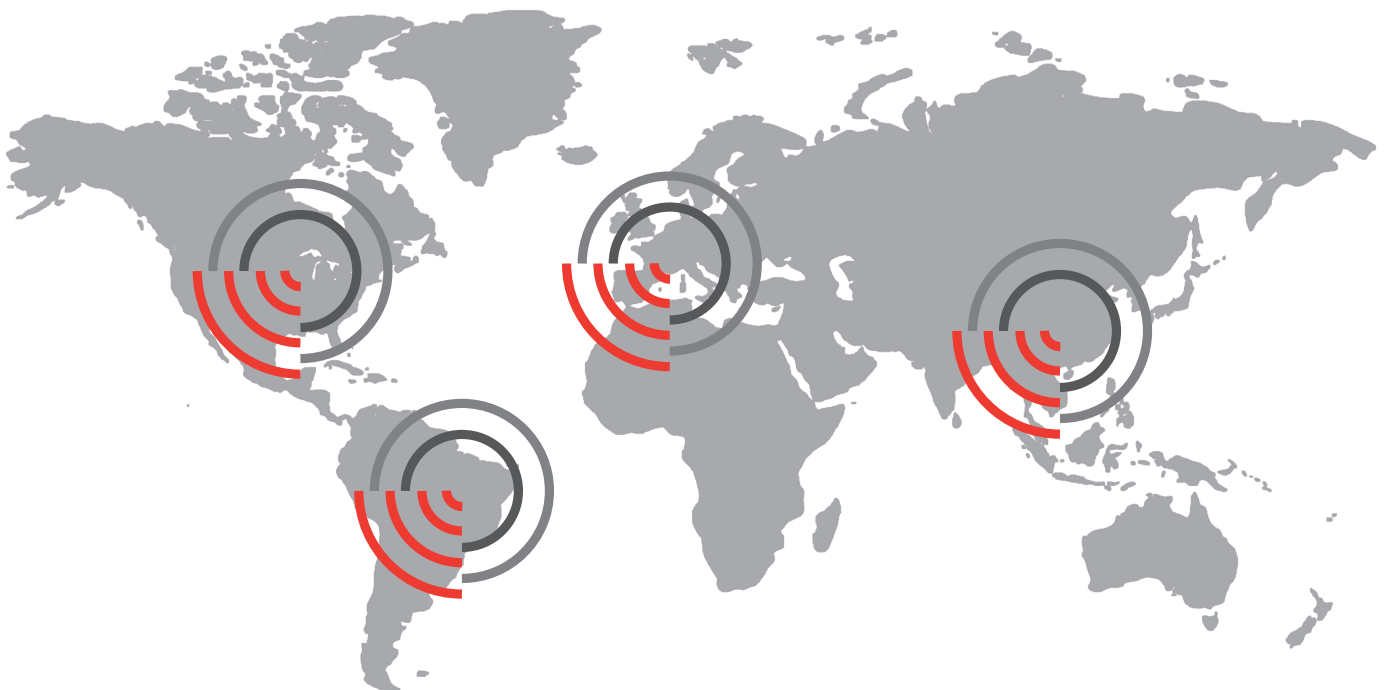

Find your local company – worldwide
www.zwickroell.com